

English



Driver & Company Manual SE5000 Digital Tachograph



Welcome

Thank you for choosing the SE5000 Rev 7.5 Stoneridge Digital Tachograph.

At Stoneridge we believe in making your life easier working as a driver or as a fleet owner. Your SE5000 Tachograph has been designed with this in mind, with functions such as simple menu options, high speed downloads, and remote download capability.

This Manual

Use this manual to familiarize yourself with how to operate the tachograph (Vehicle Unit, VU), in order to obtain the maximum use from it. The manual addresses both drivers and fleet owner companies with vehicles where the tachograph is installed.

The manual consists of three parts:

- **Driver Part** with information for the driver.
- **Company Part** with information for the company owning the vehicle.
- **Reference Part** with additional information used as a reference.

We recommend that all users read the **Driver Part** as a start. This will give you enough information to start using the tachograph. As company owners you also have to read the **Company Part** in order to understand your obligations. You can then use the **Reference Part** to look up specific details while using the tachograph.

Changes

Stoneridge Electronics reserves the right to introduce changes in design, equipment, and technical features at any time. You cannot, therefore, base any claims on the data, illustrations or descriptions in this Manual.



Certified Manual

This manual is an extended version of the certified Manual 102019P/01R04. The manual is compiled according to our customers needs. The certified version is available on internet.

www.stoneridgeelectronics.com

Copyright

This manual must not be reprinted, translated, or otherwise reproduced in whole or in part, without written permission from Stoneridge Electronics AB.

Operating Safety

Risk of accident!

Only operate the tachograph while the vehicle is stationary. Operating the tachograph while driving will distract your attention from the traffic and you may cause an accident.

Internet Information

Further information about Stoneridge Digital Tachograph SE5000 and about Stoneridge Electronics Ltd can be found at:

www.stoneridgeelectronics.com

Don't open the Case

The tachograph has been installed by authorised personnel.

A tachograph case must never be opened. No tampering with or modifications to the tachograph system are permitted. A tamper label is placed inside the printer housing. The tamper label must not be torn apart.

Here you can see where the tampering label is placed and how it looks when it is untouched.

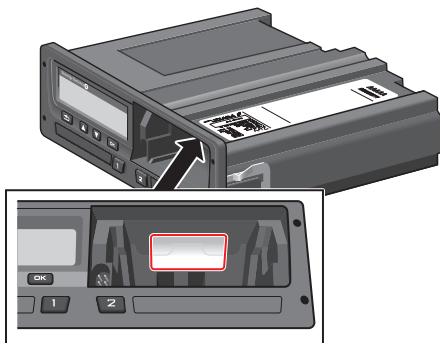

A tampered label might look like this.

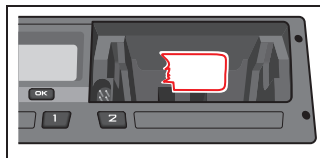

Note!

Unauthorized persons that modify this equipment are committing a punishable offence, depending on the legislation in the country concerned.

Other Documents

Besides this Driver & Company Manual there are a number of other documents that contain information about the tachograph.

- **Driver Quickguide** - Gives quick information about how to handle the tachograph as driver.
- **Company Quickguide** - Gives you as fleet owner a quick lesson in how to use the tachograph.
- **Workshop Manual** - Contains information for certified digital tachograph workshops. This information is only handed out to workshops qualified by Stoneridge training program.
- **Control Manual** - Contains information for control officers on how to carry out controls on the tachograph and the driver situation.

Contents

Welcome	1	Time Left Driving	11	DDS in Driver Scenarios	20
This Manual	1	Time Left Resting	11	Start Driving with DDS	20
Changes	1	Driver 1 and Driver 2	12	Time Left Driving	21
Copyright	1	UTC Date and Time	12	Warning and Pre-warning ...	21
Operating Safety	1	Local Date and Time	12	Taking a Break	21
Internet Information	1	Ferry/Train	13	Towards the End of the Day ...	22
Don't open the Case	2	Working Time	13	Weekly Driving Time Limit	22
Other Documents	2	Menus	13	Calendar Time Limit	22
Contents	3	How are Activities Registered? ..	14	Ferry or Train Scenario	23
Driver Part	7	Manually Registered Activ-		Activate Ferry/Train condition ..	23
The SE5000 Tachograph	8	ities	14	Driving Out of Scope	23
Card Trays	8	Before you Start Driving	15	More on Time Left Driving	24
Printer Panel	8	Insert a Card	15	DDS Calculations and Lim-	
Buttons	9	At the End of the Day	16	itations	24
Display	9	Eject (Withdraw) Driver Card ...	16	Period of Availability (POA)	24
Motion Sensor	9	Data Stored on the Card	16	In DDS calculations	24
Dashboard Integration	9	Two Driver Scenario	16	In WTD calculations	24
Different Display Views	10	Begin and End Places	17	INFO Menu	25
Display Views in DDS ON	10	At Card Insertion	17	How to reach INFO MENU	25
Display View in DDS OFF	10	Manual Entries	17	Calendar Time Left until Rest	26
Default Display	10	Change a Manual Entry	19	Cumulated Driving Time	
Current Speed	11	Clear all Entries	19	Driver 1/2	26
		Selection of Activity	19	Time to Download and Cal-	
		Working Time Directive (WTD) ...	20	ibrate	26

Revision	27	Inspection Fails	36	Show Download Process	43
Company Locked in	27	Workshop Inspection	37	WTD Presentation ON/OFF	43
Driver Settings	27	Lock-in/Lock-out Data	38	D8 Data Format	43
Change Language	28	Selling the Vehicle	38	Set Activity when Switching	
DDS Presentation ON/OFF	28	When inserting a Company		Ignition Key on/off	44
DDS Warnings ON/OFF	28	Card	38	Set Timeout for Manual Entries	44
Change Time	29	Another Company still Locked-		Set Vehicle Registration Num-	
Change Local Time	29	in	38	ber (VRN)	45
Daylight Saving Time	29	Lock-in Data	39	DDS Settings	45
Invert Colours on the Display .	30	Lock-out Data	39	Table with all DDS Settings ..	45
View Vehicle Registration Num-		Downloading - why?	40	DDS Displays	46
ber	30	Equipment	40	WTD Settings	47
Power Saving Mode	30	Downloading Procedure	40	Reference Part	49
Care of Tachograph	31	Keep a Record	41	Symbols	49
Care of Cards	31	Certificate - when not Down-		Symbol Combinations	51
Card damaged, lost or stolen ..	31	loadable	41	Available Languages	51
Printouts	31	Download with Control Card ..	41	Available Countries	52
Printout Data on Paper	31	Company Card	42	Built-in Test	54
View Data on the Display	32	Data Stored at Lock-in/out or		Display Messages	56
Change the Paper Roll	32	Download	42	Printout Examples	68
Company Part	35	Company Card Stored Data	42	Daily Printout (card)	69
Company Inspection	36	Tachograph Stored Company		Daily Printout (card) continued ..	70
Keep a Record	36	Activity Data	42	Daily Printout (VU)	71
		Company Settings	43		

Daily Printout (VU) continued	72	Operating Temperature	85
Events and Faults (card)	73	ADR Tachograph	86
Events and Faults (VU)	74	Hazardous Goods Vehicles	86
Drive Time Info	75	The ADR Tachograph	86
Technical Data	76	Visible Differences	86
Overspeeding	77	Contact Stoneridge	87
Vehicle Speed	78	United Kingdom	87
Engine Speed (rpm)	79	France	87
Status D1/D2	80	Germany	87
Manual Entry Sheet	81	Italy	87
Data and Specifications	82	Netherlands	87
DDS Calculations and Limits	82	Spain	87
DDS in Details	82	Sweden	87
Certification and Approval	83	Index	88
Avoid High Voltage	83		
Data stored in the Tachograph	83		
Insertion and Withdrawal Data	83		
Driver Activity Data	84		
Other Data	84		
Data stored on the Card	84		
Insertion and Withdrawal Data	84		
Driver Activity Data	84		
Electromagnetical Compability	84		
Tachograph Version	85		

Driver Part

The Driver Part contains the following:

- **The SE5000 Tachograph** - a presentation on what you can see on the SE5000 Tachograph, the card tray, printer panel, buttons and the different displays. Finally, information on how activities are registered is given.
- **Before you Start Driving** - information about the most frequent handling of the tachograph.
- **At Card Insertion** - Describes how to carry out manual entries.
- **Driver Settings** - this section contains all settings available to the driver.
- **Driver Card** - how to insert and withdraw a card.
- **Printouts** - how to handle the built-in printer.

The SE5000 Tachograph

This is a brief presentation of what you can see of the tachograph. The illustration below shows what can be seen when you e.g. enter the vehicle and touch any key on the tachograph. Normally the tachograph is resting and not showing any information in the display window, but a touch of any button will wake it up.



The tachograph is also referred to as the Vehicle Unit (VU). In addition to the tachograph there is a Motion Sensor attached to the vehicle and the Tachograph. Read more about the sensor and integration with the vehicle under heading **Motion Sensor** on page 9 and heading **Dashboard Integration** on page 9.

Card Trays

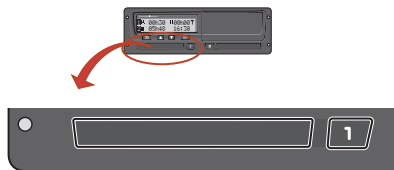

There are two card trays where you insert your driver card.

- **Tray 1** is operated by the button marked **1** and is used for the current driver card.
- **Tray 2** is operated by the button marked **2** and is used for a co-driver card.
- **Open and Close** the trays:
 - **To open** - Press the button and hold it until it opens.
 - **Close** the tray by pushing it in gently.

Printer Panel



Behind the printer panel there is a printer containing a paper cassette with a paper roll. The printer is used e.g. to make printed records of information stored in the tachograph. The printed paper will come out from a small opening at the bottom of the printer panel.

Buttons

- ⏪ **Back**
 - Moves back in a menu
 - Returns to the standard display (press repeatedly)

- ⬆ **Arrow up**
 - Moves up in the menu or a set of views
 - Increases a value
 - Toggles options

- ⬇ **Arrow down**
 - Moves down in a menu or a set of views
 - Decreases a value
 - Toggles options

- ⏹ **OK**
 - Opens the menu
 - Confirms a selection
 - Moves horizontally in a menu
 - Clears a message or warning

Display

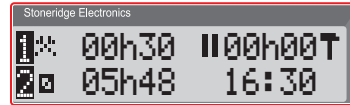

The display is, like any other display unit, used in many different ways:

- Basically the display is used to show information.
- Together with the four buttons (not the numbered buttons) the display is used to navigate in a menu system.
- The display is also used as a feedback when entering information or into the tachograph or changing settings.

Motion Sensor

The Motion Sensor, or just sensor, is transferring the motion signals from the vehicle to the Tachograph. This is a part of the Tachograph installation and must not be tampered with. Any attempt to tamper with the sensor or the sensor cable is recorded in the Tachograph.



Dashboard Integration

Some vehicles can display some of the Tachograph information on an integrated display. Here are examples on the type of information that can be displayed:

- Speed
- Travelled distance
- Accumulated Daily Driving Time
- Accumulated Driving Time
- Messages, Warnings and Faults.

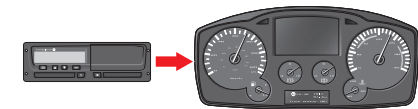

Different Display Views

The tachograph has two different standard set of Display Views that you easily can browse by using the arrow buttons.

Depending on the two settings below the set of views are different.

- **DDS ON (Driver Decision Support ON).**
- **DDS OFF (Driver Decision Support OFF).**

Display Views in DDS ON

In the standard set of Views, DDS is shown and the set of Views are:

- Default Display.
- Working Time *.
- Current Speed.
- Time Left Driving.
- Time Left Resting.
- Ferry/Train **.

* If enabled, see DDS sections for details.

** If active, see DDS sections for details.

Display View in DDS OFF

DDS can be disabled and then the set of Views contains the following:

- Default Display.
- Driver 1.
- Driver 2.
- UTC Date and Time.
- Local Date and Time.
- Current Speed.

Default Display

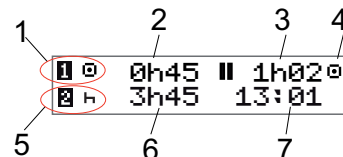

1. Driver's current activity.
2. Driving time since last break/rest if driving, otherwise duration of current activity.
3. Driver's cumulated break time.
4. Operating mode of tachograph (Operational mode is automatically entered when no card is inserted or when a driver card is inserted in the tachograph).
5. Co-driver's current activity.
6. Duration of the co-driver's activity.
7. Local time.

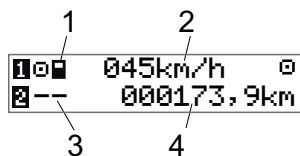
Current Speed

1. Type of card inserted in tray 1.
2. Current speed.
3. Type of card inserted in tray 2.
4. Odometer.

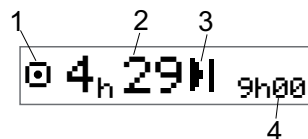
Time Left Driving

1. Time left driving view is shown.
2. Time left driving until next activity.
3. Next activity (start of daily rest).
4. How long the resting time must be to get more driving time.

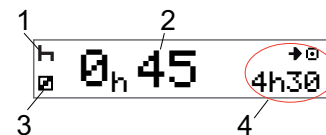
Time Left Resting

1. Driver's current activity (resting).
2. Time Left Resting until more driving time is available.
3. Co-driver's current activity (available).
4. Drive time available after this break-/rest.

Driver 1 and Driver 2

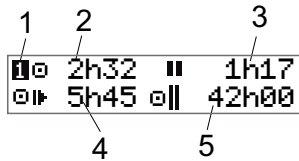

1. Indicates if driver or co-driver information is shown.
2. Drive time since last break.
3. Cumulated break time.
4. Daily driving time.
5. Cumulated driving time during the current and previous week.

UTC Date and Time

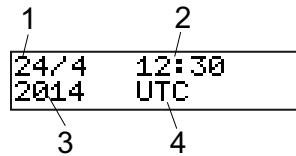

1. Date.
2. UTC time.
3. Year.
4. Indicates that it is UTC time that is used.

Local Date and Time

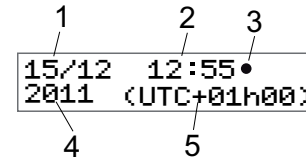

1. Date.
2. Local time.
3. Local time icon.
4. Year.
5. Local time zone offset.

Ferry/Train

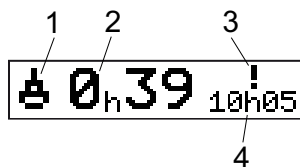

1. Ferry/Train presentation.
2. Remaining interruption time (max 1h).
3. Indication that "Interruption Time" needs to be reduced to fit the Daily rest period in a 24h period.
4. Remaining Daily Rest time.



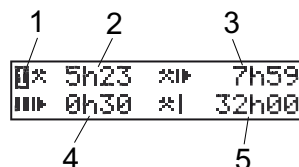

Working Time



1. Indicate that driver information is shown.
2. Working time since last break.
3. Daily working time.
4. Daily break time.
5. Weekly working time.

Menus

There are four main menus in the display, used for making selections and settings. You navigate in the menus by using the buttons on the tachograph.

-  **PRINT** Printout selections
-  **SETTINGS** Available settings
-  **PLACES** Selection of begin/end places, Out of Scope or Ferry/Train
-  **INFO** In the **INFO** menu you can toggle between five different display views, see heading **INFO Menu** on page 25.

How are Activities Registered?

Activities performed by the driver and the co-driver during the day are registered on the driver card.

Available activities:

🚗	Driving	While driving the vehicle.
🔧	Work	While working when the vehicle is standing still, for example when loading the vehicle.
📺	Available	While not working, for example when you are a co-driver.
🛌	Rest	While taking a break.
?	unknown activity	No activity type recorded.

Manually Registered Activities

The following are the two main situations when you register activities manually:

- When you need to record activities when no driver card was inserted, see above
- If the vehicle is standing still and you would like to change the current activity set by the tachograph. For example, you may change the driver's activity from **Work** to **Rest**. Press shortly on button **1** (to make selections for the driver) or on button **2** (to make selections for the co-driver) repeatedly until the desired activity is displayed. **Driving** is always selected automatically and cannot be changed.

Note!

For traffic safety reasons you may only operate the tachograph when the vehicle is standing still.

Before you Start Driving

The following scenario describes a normal working day with a single driver where:

- **Driver Card was ejected** at the end of the last working day.
- **Driver was resting** until card was inserted.
- **Driver Card is inserted** again when the new working day starts.

Note!

A driver card must be inserted in the tachograph in order to identify the driver. The driver card is personal and may not be used by anyone else but the rightful card holder.

Insert a Card

Since this is a single driver scenario card tray **1** is used. If a co-driver is present he/she must insert thier card in tray 2.

1. Press and hold button **1** on the tachograph until the tray is opened.
2. Insert the card with the chip facing forward and upwards.
3. Close the tray by pushing it carefully forward.

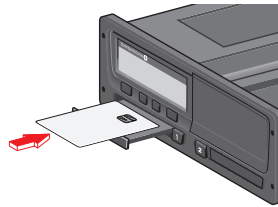

The display will, for a moment, show your name, the time for your last withdraw and then it will show:

```
Rest until
now?
```

4. Press **OK**. The display will show:

```
End country
```

5. Select the destination country of your journey and press **OK**. The display will show:

```
Begin country
```

6. Select the start country of your journey and press **OK**. The display will show:

```
Entries
printout?
```

7. Select whether or not to make a printout of the entered data by selecting **YES** or **NO** and then press **OK**.
8. Press **OK** to confirm.

The display will show:

```
Ready to
drive
```

You are ready to drive.

The card tray will be locked:

- When the vehicle is in motion.
- While the tachograph is busy processing a driver card.
- If the power supply to the tachograph is interrupted.

Note!

If end country (destination country) was selected when you ejected the card you do not need to register it again. The tachograph does not automatically prompt for begin/end place if card was withdrawn for less then 9 hours.

Note!

If the tachograph fails to read the card (driver card authentication), see heading **Display Messages** on page **56**.

At the End of the Day

When the driving is done for the day or when driver and co-driver change places, the card often will be ejected from the tachograph.

Eject (Withdraw) Driver Card

1. Press button **1** or **2** on the tachograph.

The display will show:

```
End country  
Portugal
```

2. Select your end country and press **OK** to confirm. The data is stored on the card and the tray is opened.
3. Press the card up slightly from underneath through the opening on the tray, or push the edge of the tray down until the driver card comes out.
4. Close the tray by pushing it carefully forward.

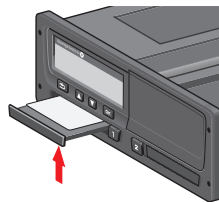

Note!

You cannot eject the card while:

- Driving
- Data on the card is being processed
- (in ADR vehicles) when ignition is OFF

Data Stored on the Card

All activities such as working, driving, and resting are registered on the driver card as well as in the tachograph. When driving the card must be inserted in the tachograph and if you change vehicle you must bring your card with you to the other vehicle. The card fits into all digital tachograph regardless of the brand. Consequently you will always have updated driver data on your card.

The driver card stores data up to the limit of its internal memory, normally at least 28 days. After this limit, new data will overwrite the oldest data.

Two Driver Scenario

The present driver's card shall always be inserted in tray **1** and the co-driver's card in tray **2**. When the drivers swap seats they have to swap the cards as well so that the driving time will be registered on the current driver's card.

Begin and End Places

When the working day starts and ends the tachograph needs to know both begin place and end place of the journey.

You can register the places at any time during the day (also during a manual entries procedure). When ejecting the driver card you will get a question about entering the end place.

To register the places during the working day, do as follows:

1. Press **OK** to show the menu.
2. Select:
PLACES
3. Press **OK** and navigate to:
Begin place
4. Press **OK** and select the place.
5. Press **OK** to confirm.
6. To register destination place, perform the same procedure again but navigate to:
End place
7. Press **OK** to confirm the destination place. Your places are registered.

At Card Insertion

When you have performed activities without the driver card inserted you need to register these activities manually. We assume that you register the activities next time you insert the driver card. Please note that all activities are entered in local time.

Manual Entries

The following scenario describes a situation when you need to register manual entries (with your card inserted). Please note that you will most likely not be able to get the same presentation on your display.

- **Friday at 15:23 18/3 2011:** You arrived and ejected the driver card.
- **From 15:23 until 18:00:** You performed other work.
- **From 18:00 over the weekend until 08:00 Monday 21/3:** You rested.
- **From 08:00 to 08:40:** You were available.
- **From 08:40 to 09:37:** You performed other work with unaccounted time.

Unaccounted time is time that should not be registered on the driver card, for example driving with an analogue tachograph.

- **Monday at 09:37 21/3 2011:** You insert the driver card.

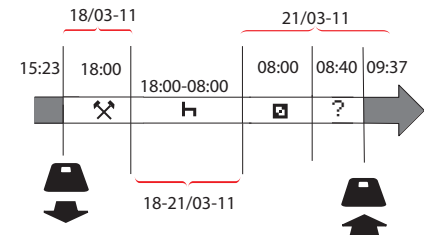

To register manual entries according to the scenario above, do as follows:

1. Insert the driver card. The display will show:
Rest until now?
2. Select **NO** and press **OK**. The display will show:
Add manual entries?
3. Press **OK**. The display will show the date and time for the last card ejection

together with the following:

end
shift

You will now register the other work you performed 18/3.

4. Highlight the ✕ symbol.



5. Press **OK**.



6. The date 18/03 is correct but 21/3 to the right needs to be changed to 18/03. Change it by scrolling back to 18/03, using the arrow buttons.



7. Press **OK** to confirm.
8. Change the time (hour) to 18 by scrolling forwards to 18.37 and press **OK**.



9. Change the minutes to 00 by scrolling forwards to 18:00 and press **OK**.



10. Press **OK** again to confirm. The display will show the date and time when the other work was finished together with:
end
shift

You will now register the time when you rested.

11. Highlight the rest symbol H and press **OK**.



12. Press **OK** to confirm the date (21/03), which already is correct.
13. Change the hour by scrolling to 08 and press **OK**.
14. Change the minutes by scrolling to 08:00 and press **OK**.
15. Since the rest was longer than nine hours, the following is displayed.
Begin country

16. Select start country and press **OK**.
17. Press **OK** again to confirm. The date and time when the rest was finished is displayed together with the following:
begin shift

You will now register the time when you were available.

18. Highlight the available symbol ▢ and press **OK**.

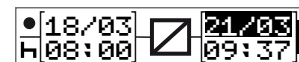

19. Press **OK** to confirm the date (21/03), which already is correct.
20. Change the hour by scrolling to 08 and press **OK**.
21. Change the minutes by scrolling to 08:40 and press **OK**.
22. Press **OK** again to confirm. The date and time when the available period was finished is now displayed together with the following:
begin shift

You will now register your work with unaccounted time. This will *not* be registered on the driver card.

23. Highlight the ? symbol and press **OK**.

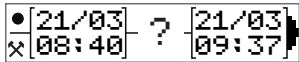

24. The time between the last activity (unaccounted time) and the time when the card was inserted is displayed, which is correct). Press **OK** to confirm
25. Press **OK** again to confirm. You have now registered all work, rest, available time, and unaccounted time for the period when no card was inserted. The following will be displayed:

```
Entries
printout?
```

26. Select whether or not to make a printout of the entered data by selecting **YES** or **NO**. We assume that you will not make a printout (for information about printouts, see section heading **Printouts** on page 31).
27. Press **OK**. The following is displayed:

```
Confirm
entries?
```
28. Press **OK** to confirm and save the entries. Now the display will show the following:

```
Ready to
drive
```

Change a Manual Entry

You can go back and change your manual entries by using the **Back** button at any time.

You can make changes at the latest before you answer **YES** on the question:

```
Confirm
entries?
```

1. Select **NO** and press **OK**.
2. Select the following:

```
Change
entry?
```

3. Press **OK** and the first manual entry is displayed again.
4. Navigate to the entry that you will change. Carry out the changes according to the procedure above.

Clear all Entries

To start over again, do as follows when the following is displayed:

```
Confirm
entries?
```

5. Select **NO** and select:

```
Clear all
entries
```

6. Press **OK** and register new entries according to the procedure above.

Note!

The manual mode will be closed when driving begins or when no interaction has been made with the tachograph for 1 or 20 minutes, depending on the settings.

Selection of Activity

When the vehicle is stopped, the following activity types can be manually selected for the driver and co-driver.

 **Work**

 **Rest**

 **Available**



1. With the Card still in the tachograph press the (1/2) button shortly. If you are the driver you must use the (1) button and if you are a co-driver you must use the (2) button.
2. Press again shortly until you have the right symbol displayed.
3. Wait for the tachograph to switch back to the selected view (that you previously have selected).

Working Time Directive (WTD)

This version of the Stoneridge Digital Tachograph supports the EU Working Time Directive (2002/15/EC).

DDS in Driver Scenarios

DDS includes both the Working Time Directive and the Ferry/Train Mode in the calculations.

DDS is described in a driving scenario that has the following components:

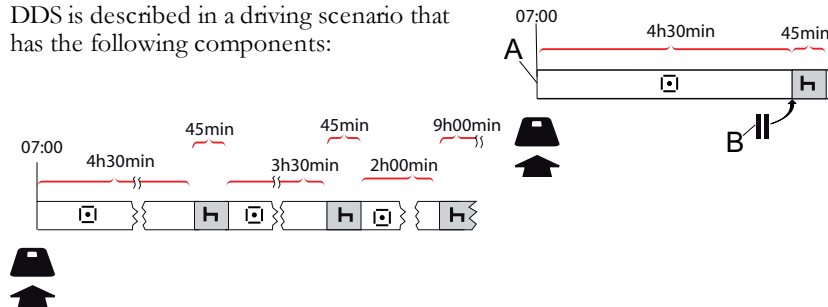

The main part of this scenario will be described below together with the Time Left Driving View.

Start Driving with DDS

Assume that you start driving in the morning at e.g. at 7 in the morning. In the illustration below you insert the card and start driving at the same time (A).

According to the current regulations you are allowed to drive for 4 hours and 30 minutes before you have to make a 45 minutes break (or 15 + 30 minutes). The end of the accumulated driving time is marked with the symbol at position (B).

Time Left Driving

DDS keeps track of your driving time and shows the Time Left Driving.

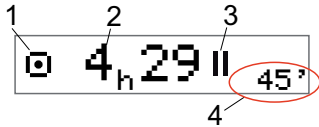

1. Icon is indicating that this is the Time Left Driving View.
2. You can drive for 4 hours and 29 minutes before you must take a break.
3. Next required activity will be a break.
4. Next required break must be at least 45 minutes.

Warning and Pre-warning

When there is 15 minutes remaining to drive the tachograph will give a Pre-warning. A Warning will be shown when you must stop driving.

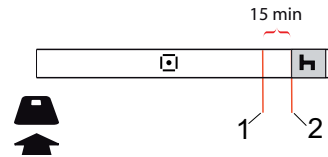

1. Pre-warning - will be shown 15 minutes before Time Left Driving has elapsed.
2. Warning - will be shown when Time Left Driving has elapsed.

Taking a Break

Similar to the Time Left Driving View the DDS will present a Time Left Resting View when you are resting.

45min

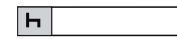

This is the first break after 4.5 hours driving.

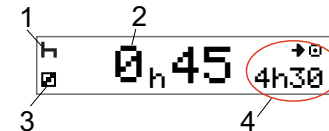

1. Driver is resting.
2. Remaining resting time is 45 minutes.
3. Availability is the activity selected for the co-driver.
4. You can drive 4 hours and 30 minutes when you have finished your rest.

Towards the End of the Day

At the end of the day, the next activity has changed to Daily Rest instead.



After a day with: 4.5 hour driving, 45 minutes break, 3.5 hours driving, 45 minutes break and finally driving for 1 hour and 28 minutes, the following is shown.

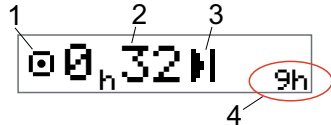

1. Icon is indicating that this is the Time Left Driving View.
2. You can drive for 32 minutes before you must take a rest.
3. Icon showing the next required activity will be the Daily Rest.
4. Showing that you will have to take a 9 hour rest.

Weekly Driving Time Limit

When the weekly drive time limit is near, the view will look like this:

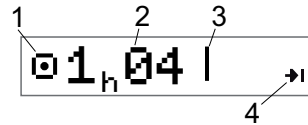

1. Icon is indicating that this is the Time Left Driving View.
2. Time left to drive this week.
3. Icon showing that you must fulfil your Weekly Rest.
4. Icon indicating that you must wait for the next week to get more driving time. You must wait for the next UTC week.

Calendar Time Limit

The drive time left view will show this when the next activity required will be a weekly rest:

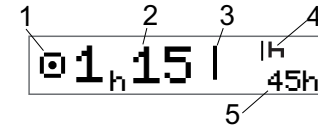

1. Icon is indicating that this is the Time Left Driving View.
2. Time left to drive this week.
3. Icon showing that you must fulfil your Weekly Rest in order to get more driving time.
4. Icon showing the Weekly Rest has to be started immediately after the Driving Time has elapsed.
5. Showing the duration of the rest (45 hours).

Ferry or Train Scenario

When taking your regular daily rest in conjunction with travelling by ferry or train there is a possibility to interrupt the rest twice to embark and disembark the ferry or train. For DDS to calculate the daily rest correctly enter Ferry/Train special condition just before starting to embark/disembark the ferry/train according to picture below.

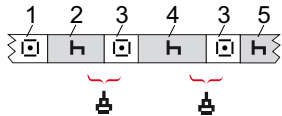

1. Driving to ferry/train
2. Rest during waiting time at the ferry-/train terminal.
3. Driving during embarkation/disembarkation of the ferry-/train.
4. Rest during ferry/train journey.
5. Continued rest after ferry/train journey.

The total driving time interruption (3 and 3) must not exceed 60 minutes.

Activate Ferry/Train condition

To activate the ferry/train condition (when standing in the queue or on-board the ferry/train):

1. Press **OK** to show the menu.
2. Select:
PLACES
3. Press **OK** and select:
ferry/train
4. Press **OK** to confirm. The ferry/train activity is activated.

The Ferry train view (see heading **Ferry-/Train** on page 13) will automatically appear if conditions are correct for a "daily rest interrupted by ferry/train"

Note!

Please remember that the activity still needs to be changed to rest after embarking the ferry.

For more information also see heading **Data and Specifications** on page 82.

Driving Out of Scope

Some driving conditions do not require recording of time on the tachograph, for

example driving in countries where no such legislation exists. This driving mode is called out of scope.

For detailed information, see national regulations and EU tachograph regulations 561/2006.

To activate or deactivate the out of scope mode:

1. Press **OK** to show the menu.
 2. Select:
PLACES
 3. Press **OK** and select:
Out of scope
 4. Press **OK**.
- If you turned the out of scope mode on, the Default Display View will show:

OUT

The out of scope mode is activated.

- If you are turning off the out of scope mode, the display will show:

**End out
of scope?**

5. Press **OK** to confirm. The out of scope mode is deactivated.

More on Time Left Driving

The Time Left Driving View can hold different information during a driving scenario.

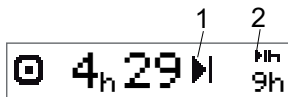

The following pictogram can be shown in position (1) and have the following meaning:

- Time for break 45 or 15 + 30 min
- Time for daily rest 11 or 9 hours
- | Time for weekly rest or weekly drive time limit reached. 45 or 24 hours or wait until next week
- || 2-weeks drive time limit reached Wait until next week

If a pictogram (2) is shown, it has the following meaning:

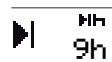

A daily rest must start immediately when the remaining time is zero.

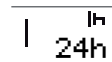

A weekly rest must start immediately when the remaining time is zero.



Working time is the cause of next break or rest.

DDS Calculations and Limitations

The Reference Part contains a more detailed description of the DDS calculations and limitations. See heading **Data and Specifications** on page 82.

Period of Availability (POA)

In DDS calculations

In the Driver Decision Support mode the POA can be calculated as break (YES) or not calculated as break (NO).

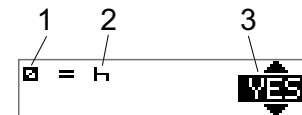

1. Pictogram for availability.
2. Pictogram for break.
3. The command can be toggled between YES (POA calculated as break) and NO (POA *not* calculated as break).

In WTD calculations

Due to different regulations in European Union the period of availability can be calculated either as a *break* or as *work*.

In the Working Time Directive mode the POA can be calculated as work (YES) or not calculated as work (NO).

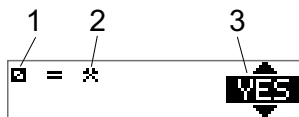

1. Pictogram for availability.
2. Pictogram for work.
3. The command can be toggled between YES (POA calculated as work) and NO (POA *not* calculated as work).

INFO Menu

When you select the Info menu the following Views are presented:

- Accumulated Driving Time Driver 1.
- Accumulated Driving Time Driver 2.
- Local Date and Time.
- UTC Date and Time.
- SE 5000 revision and Software Identification Number.
- Company Locked in.
- Time to Download and Calibration.
- Calendar Time Left to Rest.

Note!

The Info menu is only available when the vehicle is stationary.

How to reach INFO MENU

You can reach the INFO Menu in the following way:

1. Press **OK** to show the menus.
2. Select:
INFO
3. Press **OK**.

Now, you can use the arrow buttons to move between the different views.

Calendar Time Left until Rest

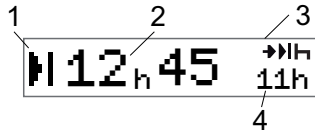

1. Calendar Time until Rest icon.
2. Calendar time left until a rest must start.
3. Icon indicating that next rest must be a daily rest.
4. Indicates how long the resting time must be (11 hours in this case).

Cumulated Driving Time Driver 1/2

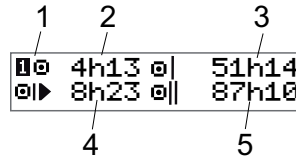

1. Driver 1 (there is a similar display for driver 2).
2. Continuous Driving Time.
3. Cumulated Weekly Driving Time.
4. Cumulated Daily Driving Time.
5. Cumulated 2-Week Driving Time.

Time to Download and Calibrate

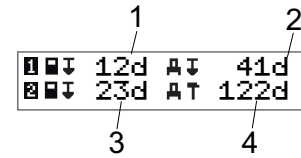

1. Days left until the Driver 1 Card has to be downloaded.
2. Days left until tachograph data has to be downloaded.
3. Days left until the Driver 2 Card has to be downloaded.
4. Days left until the tachograph has to be calibrated.

Revision

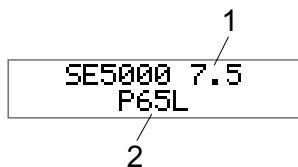

1. SE5000 Revision.
2. Software Identification number.

Company Locked in

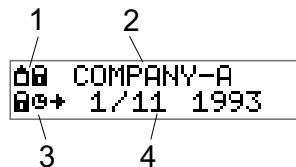

1. Company Locks pictogram combination.
2. Name of company with an active lock.
3. Pictogram indication lock in starting time.
4. Date when company data was locked in.

Driver Settings

The driver can make the following settings:

- Change Language
- Enable/Disable DDS Presentation
- Enable/Disable DDS Warnings
- Change Time
- Change Local Time
- Daylight Saving Time
- Invert Colours on the Display
- View Vehicle Registration Number (VRN)
- Enable/Disable WTD Presentation

Change Language

By default, it is the driver card language that is used in the tachograph and on printouts, but you can change which language is to be used.

If you change language, the new language will be saved only in the tachograph, not on the driver card.

1. Press **OK** to show the menu.
2. Select:
`SETTINGS`
3. Press **OK** and select:
`Language`
4. Press **OK** and select the desired language.
5. Press **OK** to confirm. The language is changed.

DDS Presentation ON/OFF

By default the DDS (Driver Decision Support) is enabled (ON), but it can be switched OFF which means that not only the presentation is switched off but also all warnings associated with the DDS.

1. Press **OK** to show the menu.
2. Select:
`SETTINGS`
3. Press **OK** and select:
`DDS Settings`
4. Press **OK** and select:
`DDS enable`
5. Select **OFF** to disable the DDS presentation.
6. Press **OK** to confirm. The DDS presentation is now disabled.

DDS Warnings ON/OFF

By default the DDS warnings (Driver Decision Support) are enabled (ON), but they can be switched OFF.

1. Press **OK** to show the menu.
2. Select:
`SETTINGS`
3. Press **OK** and select:
`DDS Settings`
4. Press **OK** and select:
`DDS warnings`
5. Select **OFF** to disable the DDS warnings.
6. Press **OK** to confirm. The DDS warnings are now disabled.

Change Time

All tachograph activities are registered in UTC time (Universal Time Coordinated) which more or less corresponds to GMT (Greenwich Mean Time). The time is not automatically adjusted to summer/winter time (daylight saving time/normal time).

You can change the UTC time by one minute per week (plus or minus) and that can be important especially when you move from one vehicle to another.

If the time has deviated more than 20 minutes the tachograph must be calibrated by a digital tachograph workshop.

1. Press **OK** to show the menu.
2. Select:

SETTINGS

3. Press **OK** and select:

UTC time

4. Press **OK**.
5. Change the time, using the arrow buttons.
6. Press **OK** to confirm. The time is changed.

Change Local Time

Local time is the current time in a specific country. Local time is only shown as information on the display and on some printouts. The local time is set manually and can be adjusted in steps of 30 minutes.

1. Press **OK** to show the menu.

2. Select:

SETTINGS

3. Press **OK** and select:

Local time

4. Press **OK**.
5. Change the time, using the arrow buttons.
6. Press **OK** to confirm. The local time is changed.

Daylight Saving Time

In EU countries, the last Sunday in March and October the tachograph will remind you to change the local time according to Daylight Saving Time (local summer/winter time).

1. When adjustment is needed, the display will show:
New time?
2. Press **OK** to confirm. The local time is changed.

Invert Colours on the Display

There are two modes for the display: dark background with light text or light background with dark text.

1. Press **OK** to show the menu.
2. Select:

SETTINGS

3. Press **OK** and select:

Invert display

4. Press **OK** to confirm. The display is inverted.

To reset the display, follow the same procedure but select **NO** in step 3.

View Vehicle Registration Number

The Vehicle Registration Number (VRN) can be viewed by the driver but it needs a company card to set it, see heading **Set Vehicle Registration Number (VRN)** on page 45.

1. Press **OK** to show the menu.
2. Select:

SETTINGS

3. Press **OK** and select:

Reg. Number

4. Press **OK** to confirm. The vehicle registration number is displayed.

Power Saving Mode

When the ignition key is switched off the tachograph will turn to power saving mode ten minutes after the last interaction. In power saving mode the display is off.

The display will be switched on again when:

- Pressing any button once
- Switching the ignition key on
- Taking the vehicle in tow

Care of Tachograph

To obtain a long and trouble-free lifetime for the tachograph please keep the following in mind:

- Keep the trays closed at all times and only open them to insert and withdraw a card.
- Do not place objects on the trays when they are open, otherwise they could be damaged.
- Keep the tachograph clean.
- Clean a dirty tachograph with a damp, soft cloth.

Care of Cards

Treat your card with care and please note the following:

- Do not flex or bend the card.
- Ensure that the card contacts are kept free from dirt and dust.
- Clean it with a soft damp cloth if necessary.
- Protect it from damage.

Card damaged, lost or stolen

If the card is damaged, lost or stolen the owner has to request a replacement card from the responsible authority in the country where the card was issued.

If a card is stolen or if the owner suspects that an unauthorized person has access to the card, the owner has to report the incident to the local police and obtain a police report number.

A driver without a valid driver card is not permitted to drive a vehicle equipped with a digital tachograph.

Printouts

You can view the information stored in the tachograph and on the driver cards by printing it on paper or by showing it on the display. There are a number of different presentations available, which you can read more about in section heading **Printout Examples** on page 68

Printout Data on Paper

1. Press **OK** to show the menu.
 2. Select:
PRINT
 3. Press **OK**.
 4. Select the type of printout to make and then press **OK**.
 5. Some types of printouts require specification of the driver card and a date. If so, the display will show:
Select card 1 or 2
- Select **1** to make a printout for the current driver's card or **2** to make a printout for a co-driver's card. The display will show:

```
Select date  
09/11 2011
```

- Select the desired date by using the arrow buttons and press **OK**.
- 6. Select:

```
printer
```
- 7. Press **OK**. The display will show:

```
Printing  
busy
```
- 8. Wait until the message is cleared and then pull the printout upwards to tear it off. (If you would like to cancel the process, press and hold the  button.)

Note!

To avoid paper jam make sure the slot on the paper cassette is not blocked.

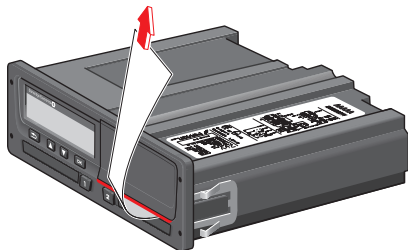

View Data on the Display

1. Press **OK** to show the menu.
2. Select:

```
PRINT
```
3. Press **OK**.
4. Select the type of printout to make and then press **OK**.
5. Some types of printouts require specification of the driver card and a date. If so, the display will show:

```
Select card 1 or 2
```
- Select **1** to make a printout for the current driver's card or **2** to make a printout for a co-driver's card. The display will show:

```
Select date
```
- Select the desired date by using the arrow buttons and press **OK**.
6. Select:

```
display
```
7. Press **OK**. Scroll through the data using the arrow buttons and then press **OK** to return.

Change the Paper Roll

Note!

To avoid malfunctioning only use printer paper approved by Stoneridge.

1. Press the upper edge of the front panel. The panel opens.



2. Hold the lower edge of the panel and carefully pullout the cassette.

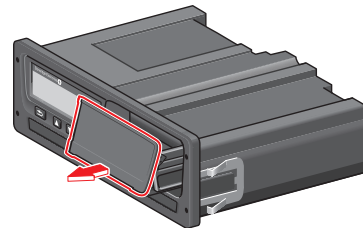

3. Feed the paper around the back of the paper cassette and forwards, passing the lower edge of the panel.

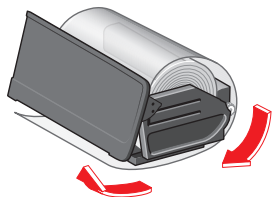

4. Insert the paper into the printer.
5. Slide the paper cassette into the tachograph and press the lower part of the panel to close.

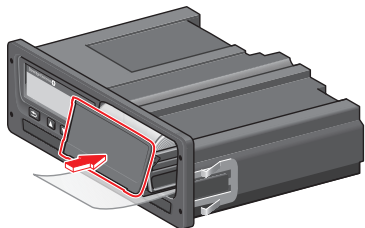

6. Pull the paper upwards and tear it off.

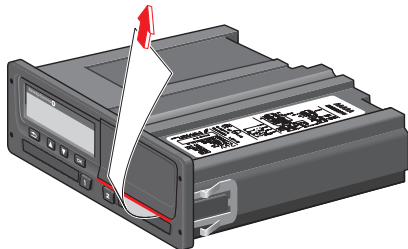

Company Part

The Company Part contains information especially for the vehicle owners and hauliers who have certain responsibilities that are described in the following main sections:

- **Company Inspection** - the company is obligated to carry out inspections of the Tachograph and keep records.
- **Workshop Inspection** - the company has to administrate a workshop inspection of the Tachograph and store records from the inspection.
- **Lock-in and Lock-out Data** - the company can lock in data in order to make the data out of reach for unauthorised persons. This together with a reset function (lock-out data) is described here.
- **Download Data** - the company is obligated to carry out download of tachograph data.
- **Company Card** - contains information about the company card.
- **Company Settings** - a few settings are only available for the company staff and these settings are found here.

Note!

The company must make sure that all their vehicles over 3.5 tons are equipped with digital tachograph systems according to EU regulations and national laws. The company card is personal and may not be used by anyone else but the rightful card holder.

Company Inspection

The company inspection shall ensure that:

- The Type Approval Number is correct.
- The UTC time is accurate by less than 20 minutes.
- The tachograph is within the correct calibration interval.
- The installation plaque is time valid and not broken.

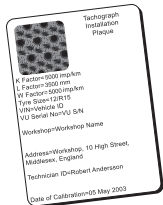

- The tamper label is not torn apart.

The company inspection should also ensure that:

- The stored calibration factors agree with what is recorded on the installation plaque.
- The tachograph's internally stored vehicle parameters (Vehicle

Identification Number [VIN] and Vehicle Registration Number [VRN]) agree with the actual vehicle data.

- The tachograph does not have any visible damage.

Keep a Record

Keep a record of the Company Inspection.

Inspection Fails

If there are faults in any of the items included in a company inspection, or if there is any doubt regarding the company inspection, the vehicle must be taken to a digital tachograph workshop for inspection.

If not it will result in a decision that the company is breaking EU, EEA and AETR tachograph regulations and the vehicle, in which the tachograph is fitted, will be invalid for use.

Note!

Consult relevant authority for national regulations.

Workshop Inspection

The tachograph installation has to undergo a workshop inspection every second year. It is the company's responsibility to administrate this inspection and to take care of records from the inspection (carried out at a Digital Tachograph Workshop).

The installation plaque, fixed near the tachograph, states the date for passed inspection.

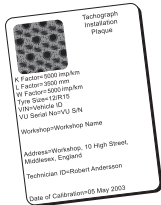

Note!

At the inspection the installation plaque must be valid and not broken.

Ensure that the information in the tachograph test certificate received after a workshop periodic inspection is accurate.

The following records must be taken care of by the company:

- Test Certificates from the Workshop.
- Undownloadability certificates, see heading **Downloading - why?** on page 40.

Data must be available in the event of an enforcement authority investigation or audit.

Lock-in/Lock-out Data

The company owner can lock-in tachograph data in order to make them unreachable for unauthorized persons.

We recommend that the Lock-in Data is carried out before the tachograph is being used. If Lock-in is carried out at a later time all data up to this time will be unlocked and available.

Selling the Vehicle

In case the vehicle will be sold, a lock-out data procedure has to be performed before the vehicle is handed over to the new owner. If not there will be a risk for a mix up in the storing of data.

When inserting a Company Card

When a Company card is inserted SE5000 will automatically ask if a Company Lock shall be activated.

```
Company  
lock-in
```

If the inserted card already has an active lock no question will be asked.

1. Select **YES** and press **OK**.
The following display appears for a short time:

```
Lock-in  
complete
```

You can later at any time show the lock-in/out status by selecting the INFO menu, see heading **How to reach INFO MENU** on page 25.

Another Company still Locked-in

If a lock-in is performed and there is another company still locked-in, the tachograph will automatically perform a lock-out of the previous company. No data will be lost for any company.

Lock-in Data

If company data is not locked-in, the Lock-in menu is shown after insertion of a company card. In addition lock-in can be carried out at any time.

1. Press the **OK** button to show the tachograph menu.

2. Select:

```
COMP LOCKS
```

3. Press **OK**.

The display will show:

```
Company  
lock-in
```

5. Select **YES** and press **OK**.

The following display appears for a short time:

```
Lock-in  
complete
```

If the last lock-out was made by the present company, that lock-out will be cancelled and the present company lock-in will be extended to the date and time for the previous lock-in.

Note!

The tachograph is able to handle a maximum of 255 company locks. After

that the oldest company lock will be removed.

Lock-out Data

A lock-out must be performed before the tachograph is transferred to another company or if there is a risk of getting the next company's data recorded. If the lock-out is forgotten, the data will not be locked-out until the next company performs a lock-in.

1. Insert a company card in tray 1 or 2.
The tachograph automatically enters the company mode of operation.

If two company cards are inserted the last inserted will be ejected.

2. Press the **OK** button to show the tachograph menu.
3. Select:

```
COMP LOCKS
```

4. Press **OK**.
5. Select **YES** and press **OK**.

The display will show:

```
Company  
lock-out
```

6. Select **YES** and press the **OK** to perform the lock-in.

The following display appears for a short time:

```
Lock-out  
complete
```

Downloading - why?

The available space on the cards and in the tachograph is limited and when the memory is full the information will be overwritten by new information and thereby it will be lost for ever.

To avoid this and to secure card and tachograph data a frequent download of information is needed. It means that data will be transferred from the card/tachograph to a data storage outside the vehicle.

Data has to be downloaded regularly. Please note that downloading will not destroy any data. Data is only erased (destroyed) when it is overwritten by new data or by an accident.

Note!

Consult the relevant authority for more information.

Equipment

Downloading of stored data from the tachograph memory or an inserted driver card is done by attaching a download equipment. For the best result, Stoneridge Electronics recommends OPTAC. Other download equipment compliant with the protocol as laid out in the legislative document 1360/2002 Annex 7 can also be used.

Also remote download is possible but it is not described here.

Many types of equipment can download cards directly by inserting them in a card holder on the equipment in question.

The equipment used for downloading will generate a digital signature that will be stored together with the downloaded data.

Downloading Procedure

Note!

If a driver card is inserted in tray 1, insert the company card in tray 2 to perform the download.

1. Remove the printer cassette.
2. Attach the download equipment to the tachograph through the 6-way front download connector.

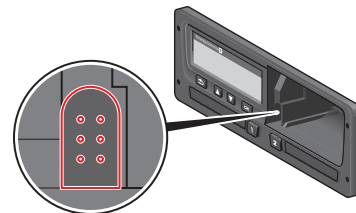

3. Start downloading data according to the instructions on the download equipment.

The tachograph will show:

Downloading busy

When downloading is completed, the following message will be displayed:

Downloading complete

If the downloading process failed the display will show the following warning:

Download failure

See heading **Display Messages** on page 56

Keep a Record

Store all downloaded data in a secure suitable way. This will prevent unauthorised access of data.

Data must be available in the event of an enforcement authority investigation or audit.

Certificate - when not Downloadable

If it is not possible to download data from a faulty tachograph at the workshop, they will issue a certificate of not downloadable information.

Such certificate received from a workshop must be securely stored. The certificate must be available to the enforcement authorities during any investigation or audit.

It is good practice to keep a register of undownloadability certificates issued from a digital tachograph workshop.

Note!

If a workshop receives a written request from an enforcement authority, a copy of stored downloaded data might be given to the authority for the purpose of investigation without the permission of the data owner.

Download with Control Card

With a valid control card enforcement authorities can download data for investigation purposes.

Company Card

Company Cards are issued by the responsible authorities in respective EU, EEA and AETR country (EU - European Union, EEA - European Economical Area, AETR - United Nation's agreement on International Road Transport). A company may have several Company Cards.

The Company Card must be inserted in the tachograph in order to identify the company.

Note!

If the tachograph fails to read the card (company card authentication), see heading **Display Messages** on page **56** and look for:

```
Card 1auth.  
failure
```

The Company Card can be authenticated remotely. If remote authentication fails, the user will be notified by the user interface. This will not be visible on the VU-display.

The card tray is locked when the vehicle is in motion, while the tachograph is busy processing the company card and if the

power supply to the tachograph is interrupted.

The Company Card can store a minimum of 230 records. The maximum number of records is dependent on the card type. When the upper limit is reached the oldest data will be overwritten.

Data Stored at Lock-in/out or Download

Each time a company card is inserted into a tachograph a record of card activity is stored on the company card and in the tachograph.

- Date and time of the company activity.
- Type of activity performed.
- Period downloaded, if applicable.
- Vehicle Registration Number (VRN) and country registration authority of the vehicle used for the activity.
- Driver card number and card issuing country, in case of a card download.

Company Card Stored Data

A single record of the company card activity, containing the following card and card holder information, will be stored on the company card:

- Card number.
- Issuing country, issuing authority name and the issue date.
- Card validity - start date and expiry date.
- Company name and address.

Tachograph Stored Company Activity Data

Each time a company card is used to carry out a tachograph activity a record is stored in the tachograph.

The data stored when performing a lock-in/lock-out is:

- Lock-in date and time.
- Lock-out date and time.
- Company card number and card issuing member state.
- Company name and address.

The data stored when performing a download is:

- Date and time of the download.
- Company card number.
- Card issuing member state of the card used to perform the download.

Company Settings

You must have a company card to carry out the following settings.

Show Download Process

You can select to show the Download process or blank it out.

1. Press **OK** to show the menu.
2. Select:
Setting
3. Press **OK**.
4. Select:
Parameters
5. Press **OK**.
6. Select:
Show downl. process
7. If the process must be shown - select:
YES
8. If the process not must be shown - select:
NO
9. Then press **OK** to confirm.

WTD Presentation ON/OFF

By default the WTD (Working Time Directive monitoring) is enabled (ON), but it can be switched OFF which means that not only the presentation is switched off but also all warnings associated with the WTD monitoring.

1. Press **OK** to show the menu.
2. Select:
SETTINGS
3. Press **OK** and select:
WTD Settings
4. Press **OK** and select:
WTD enable
5. Select **OFF** to disable the WTD presentation.
6. Press **OK** to confirm. The WTD presentation is now disabled.

D8 Data Format

1. Press **OK** to show the menu.
2. Select:
SETTINGS
3. Press **OK**.
4. Select:
Parameters
5. Press **OK**.
6. Select:

D8 data format

7. For SRE proprietary format - select:
SRE
8. For legacy format - select:
2400
9. Then press **OK** to confirm.

Set Activity when Switching Ignition Key on/off

You can select an activity to automatically be selected when switching the ignition key on or off. The activity change will apply to both the driver and the co-driver.

1. Press **OK** to show the menu.
2. Select:
SETTINGS
3. Press **OK**.
4. Select:
Parameters
5. Press **OK**.
6. Select one of the following (depending on which setting you wish to make):
Default activ. key on

Default activ. key off

7. Press **OK** to confirm.

Set Timeout for Manual Entries

The manual entries will be closed when no interaction has been made for 1 or 20 minutes, depending on the settings. As default the timeout is 1 minute.

1. Press **OK** to show the menu.
2. Select:
SETTINGS
3. Press **OK**.
4. Select:
Parameters
5. Press **OK**.
6. Select:
Man. entries timeout
7. Press **OK**.
8. Select one of the following:
1 min
20 min
9. Press **OK**.

Set Vehicle Registration Number (VRN)

Normally a Vehicle Registration Number (VRN) is set during installation. But if the VRN is missing you can enter it yourself. The number can only be registered once by the company.

1. Press **OK** to show the menu.
2. Select:
`SETTINGS`
3. Press **OK**.
4. Select:
`Reg. Number`
5. Press **OK**.
6. `Enter Reg. Number` is displayed. Press **OK**.
7. Select preferred character set (default set is Latin 1) and press **OK**.
8. Select the character for the first character in the vehicle registration number and press **OK**. Repeat until the complete number is entered. 13 characters can be entered.
9. Select the `↓` symbol and press **OK**.
10. Press **OK** to confirm. The vehicle registration number is set.

DDS Settings

For the company a number of DDS settings are available, see the Table with all DDS Settings.

Table with all DDS Settings

This table contains all DDS settings.



- on/off - the presentation can be switched on (enabled) or switched off (disabled).
- days - is a setting for how many days in advance a warning or pre-warning shall be presented.

DDS Displays

Display text	Setting	Description
DDS enable	on/off	Set if the DDS shall be shown or not shown. This is available for both driver and company.
DDS warnings	on/off	Set if the warnings and the pre-warnings shall be shown or not. This is available for both driver and company.
 = h	break/ no break	Set if the POA (periods of availability) shall be registered as a break. This is available for company.
9h	on/off	This is a pre-warning and a warning that will be shown when the 9 hours daily driving time is near to be reached.
daily drive time	on/off	This is a pre-warning and a warning that will be shown when the maximum daily driving time is near to be reached.
weekly drive time	on/off	This is a pre-warning and a warning that will be shown when the maximum weekly driving time is near to be reached.
2-week drive time	on/off	This is a pre-warning and a warning that will be shown when the maximum 2-weekly driving time is near to be reached.
daily/weekly rest	on/off	Pre-warning and a warning for daily/weekly rest period.
card downl. interval	days	Here the company can set the number of days between card downloads.
veh. downl. interval	days	Here the company can set the number of days between tachograph download.
drive time pre-warning	hhmm	Set how many minutes (hours) in advance the tachograph will give a pre-warning. This setting affects all pre-warnings except the continuous driving time pre-warning
card expiry pre-warning	days	Set how many days in advance the tachograph will give a warning.
card downl. pre-warning	days	Set how many days in advance the tachograph will give a warning.
veh. downl.	days	Set how many days in advance the tachograph will give a warning.

pre-warning calibration pre-warning	days	Set how many days in advance the tachograph will give a warning.
Auto DDS display	on/off	In this setting the tachograph can be set to automatically show the standard display selection.

WTD Settings

Display text	Setting	Description
WTD enable	YES/NO	Set if the WTD shall be used (enable) or not used (disable). This is available for both driver and company.
6h	YES/NO	Set if the 6 hour pre-warning and a 6h warning shall be shown or not. This is available for company.
60h	YES/NO	Set if the 60 hour pre-warning and a 60h warning shall be shown or not. This is available for company.
 = 	YES/NO	Period of Availability is calculated as work (YES) or not calculated as work (NO).
1st break	15,30,45	Set the length of the break to 15, 30 or 45 minutes

Reference Part

The reference part contains additional information that sometimes may be needed but not frequently used. This part contains:





















- **Display and Printout Symbols** - contains list of symbols used in the display and on the printouts.
- **Available Languages** - a list of languages for the display.
- **Available Countries** - a list of countries that can be selected as locations.
- **Display Messages** - an alphabetically ordered list of messages, warnings and faults that can appear on the display.
- **Printout Examples** - contains the most of the possible printouts.
- **ADR Tachograph** - a Tachograph version that is aimed for use in vehicles used for hazardous goods transports.
- **Contact Stoneridge** - how to contact Stoneridge.
- **Index**

























Keep this Driver & Company Manual in the vehicle. If the vehicle is sold, pass this manual on to the new owner as the Tachograph is considered as a part of the vehicle.



The local Stoneridge representative will be pleased to assist you if you should have any questions. You will find a list of local representatives in chapter heading **Contact Stoneridge** on page 87

Symbols

This is a list of the most frequently shown symbols on the display and on the printouts.

Symbol	Description
	Function not available
	Driver or slot
	Co-driver or slot
	Card
	Eject
	Work
	Driving/driver (mode of Operation)
	Rest/break
	Available
	Ferry / train crossing
OUT	Out of scope, -i.e. no recording is required
	Local time/location
	Start of daily work period
	End of daily work period
	Break
	From or to
	Printer, printout
	Paper
	Display
	Processing, please wait
	Time, clock
UTC	UTC time
24h	Daily

Symbol	Description
	Weekly
	Two weeks
	Total/summary
	Speed
	Over speeding
	Faults
	Events
	Pre-warning/question/unknown activity
	Workshop
	Company
	Controller
	Manufacturer
	Security
	External storage/download
	Buttons
	Finished
	Tachograph (VU), vehicle
	Tyre size
	Sensor
	Power supply
	Print
	Print, submenu
	Company lock
	Places

Symbol	Description
	Places, sub menu
	Settings

Symbol Combinations

The following combination of symbols are the most common.

Symbols	Description
●▶	Location start of daily work period
▶●	Location end of daily work period
⊞→	From time (UTC)
→⊞	To time (UTC)
●⊞	Local time
⊙⊙	Crew driving
⊙	Driving time for two weeks
OUT→	Out of scope - begin
→OUT	Out of scope - end
⊙▶	Cumulative driving time of current day
↓○	Printer low temperature
↑○	Printer high temperature
■--	No card
⊙■	Driver card
⊔■	Workshop card
⊠■	Company card
⊔■	Control card
⊔●	Control place
⊠→	From vehicle

Available Languages

When you insert your driver card the Tachograph automatically changes to the language on the card. But you can select any of the following languages.

Language	Language in English
Български	Bulgarian
Čeština	Czech
dansk	Danish
Deutsch	German
eesti	Estonian
Ελληνικά	Greek
English	English
español	Spanish
français	French
islenska	Icelandic
italiano	Italian
latviesu	Latvian
lietuviu	Lithuanian
magyar	Hungarian
Nederlands	Dutch
norsk	Norwegian
polski	Polish
português	Portuguese
română	Romanian
русский	Russian

Language	Language in English
slovenčina	Slovakian
slovenscina	Slovenian
suomi	Finnish
svenska	Swedish
shqip	Albanian
bosanski	Bosnian
hrvatski	Croatian
Македонски јаз	Macedonian
srpski	Serbian
Türkçe	Turkish
Україна	Ukraine

Available Countries

You can select the following countries as location on your Tachograph.

Country
Albania
Andorra
Armenia
Austria
Azerbaijan
Belarus
Belgium
Bosnia/Herzegovina
Bulgaria
Croatia
Cyprus
Czech Republic
Denmark
Estonia
Faeroe Islands
Finland
France
Georgia
Germany
Greece
Hungary
Iceland





Country
Ireland
Italy
Kazakhstan
Latvia
Liechtenstein
Lithuania
Luxembourg
Macedonia
Malta
Monaco
Montenegro
Netherlands
Norway
Poland
Portugal
Republic of Moldova
Romania
Russian Federation
San Marino
Serbia
Slovakia
Slovenia
Spain - regions
- Andalucía
- Aragón

Country
- Asturias
- Baleares
- Canarias
- Cantabria
- Castilla-La-Mancha
- Castilla-León
- Cataluña
- Extremadura
- Galicia
- La Rioja
- Madrid
- Murcia
- Navarra
- País Vasco
- Valencia
Sweden
Switzerland
Turkey
Turkmenistan
Ukraine
United kingdom , including:
- Alderney
- Guernsey
- Isle of Man
- Jersey

Country
- Gibraltar
Uzbekistan
Vatican City
Yugoslavia
European community
Rest of Europe
Rest of the World

Built-in Test

The built-in test can be used to check the following tachograph components for correct operation:

- Display 
- Driver card 
- Buttons 
- Printer 
- Invert display 

Perform a built-in test in the following way, but please note that the built-in test is only available when the vehicle is stationary.

1. Press the **OK** button and select:

SETTINGS

2. Press **OK** again.
3. Select:

Built-in Test

4. Press **OK**.
5. Select one of the five test categories and press **OK**.

Type of Test	Description	Action if Test Failed
□ Display	<p>Display test The display shows positive view, negative view and a pattern of rectangles for 1 second each.</p>	<p>Visit a digital tachograph workshop to have the tachograph checked if the display is unreadable.</p> <p>If the display is unreadable the tachograph has to be decommissioned and replaced.</p>
▣ Driver card	<p>Test of the inserted driver cards There must be a driver card in the relevant slot. The name of the card holder is read and displayed for 2 seconds.</p>	<p>If a card is reported as defective, check a different card to ensure that the tachograph is functioning.</p> <p>If the tachograph seems to be defective, visit a digital tachograph workshop to have the equipment checked.</p> <p>If it is the driver card that is definitely defective, contact the responsible authority in the country where the driver card was issued.</p>
⌘ Button	<p>Button test You are prompted to press the buttons one by one from left to right within 2 seconds of each other, otherwise the test fails.</p>	<p>Carefully clean dirty buttons with a damp cloth and a mild detergent.</p> <p>Visit a digital tachograph workshop to have the tachograph checked if a button repeatedly fails to work.</p>
▼ Printer	<p>Test page printed out</p>	<p>Check the paper cassette, if necessary insert a new paper roll or replace the cassette.</p> <p>Visit a digital tachograph workshop to have the tachograph checked if the printer still does not work.</p>
⌘ Inverted display	<p>Inverted display function test The display view is inverted for 2 seconds.</p>	<p>Visit a digital tachograph workshop to have the tachograph checked if the display is unreadable.</p>

Display Messages

There are four type of messages that can be seen on the display.

- **Messages** - contains information on processes or reminders to the driver. Messages are not stored and can not be printed. Press the **Back** button to clear the message.
- **Pre-warnings** - appear as early reminders to the warnings. Pre-warnings are stored and can be printed. Press the **OK** button twice to clear the Pre-warning.
- **Warnings**- appear in the event of e.g. overspeeding or violations of the law or if tachograph not can be recording. Warnings are stored and can be printed. Press the **OK** button twice to clear the Warning.
- **Faults** - are more critical than warnings and are displayed if there is a fault detected in the tachograph, in the sensor or driver card. In addition faults are presented if tampering with the equipment is detected. Faults are stored and can be printed. Press the **OK** button to acknowledge the Fault.

Display	Description	Action
	Message Entry not possible while driving. Related to the operator.	Stop the vehicle and try the entry again.
!■ Already in company mode	Message Two company cards inserted. The second card will be ejected without being processed (authenticated). Related to the operator.	Insert only one Company card.
!■ Already in control mode	Message Two control cards inserted. The second card will be ejected without being processed (authenticated). Related to the operator.	Insert only one Control card.

Display	Description	Action
!■ Already in calibration mode	Message Two workshop cards inserted. The second card will be ejected without being processed (authenticated). Related to the operator.	Insert only one Workshop card.
×■1 Card 1 fault	Fault The card in tray 1 is defective. Similar message for tray 2. Related to the card.	Eject the card and check it visually. Clean the card with a soft damp cloth and try again. Still faulty - Perform a self test, see heading on page 55 Still faulty - Visit a workshop to have the equipment checked.
!⊙⊙1 Card 1 time overlap	Warning The last withdrawal time of the inserted driver card is later than the date/time of the tachograph. Related to the tachograph.	Check the date/time of the tachograph and change if necessary. Wait for the overlap period to elapse.
!⊙■1 Card 1 auth. failure	Fault The tachograph security check for the card in tray 1 failed. Similar message for tray 2. Related to the tachograph.	Eject the card and check it visually. Clean the card with a soft damp cloth and try again. Still faulty - Perform a self test, see heading on page 55 Still faulty - Visit a workshop to have the equipment checked.
!■■ Card conflict	Warning An invalid card combination has been detected. Related	Withdraw the offending card.

Display	Description	Action
	to the card.	
!@+@2 Card integrity error	Fault Corrupt data detected when reading data from the card in tray 2 to the tachograph. Similar message for tray 1. Related to the card.	Eject the card and check it visually. Clean the card with a soft damp cloth and try again. Still faulty - Perform a self test, see heading on page 55 Still faulty - Visit a workshop to have the equipment checked.
!@→x2 Card eject without saving	Message Data could not be stored on the card withdrawn from tray 1 due to an error. Similar message for tray 2. Related to the card.	Eject the card and check it visually. Clean the card with a soft damp cloth and try again. Still faulty - Perform a self test, see heading on page 55 Still faulty - Visit a workshop to have the equipment checked.
@@1 Card expired	Message The card in tray 1 has expired. Similar message for tray 2. Related to the operator.	Remove the card and replaced it with a valid one.
@!@@ Card expiry	Message The card in tray 1 will expire (Day/Month) . Similar message for tray 2. Related to the operator.	Contact the responsible authority to get a new card.
1 Card expires in xx days	Message The card inserted in tray 1 expires in xx days, where xx is a number between 0 and 30. Similar message for tray	Contact the responsible authority to get a new card. The message disappears automatically after 5 seconds or when a button is pressed.

Display	Description	Action
	2. Related to the operator.	
!Ⓜ Card ins. while driving	Warning A driver card was inserted while the vehicle was in motion. Related to the operator.	Continue the journey if the driver card is valid.
→✓ Changes saved	Message A pop-up message to confirm that a change is saved.	No further action required.
!Ⓜ/A Data integrity error	Fault The user data stored in the tachograph has errors. Related to the tachograph	Visit a digital tachograph workshop to have the equipment checked.
?Ⓜ▶ daily drive time	Pre-warning - 9h daily drive time Warning - 9h daily drive time Pre-warning - daily drive time Warning - end of daily driving time Four different warnings for reaching the allowed driving time.	
↕×↕ Download failed	Warning A failure when trying to download data from the tachograph. Related to the tachograph/card.	Check the connector and the download equipment. Retry the download. If still faulty Tachograph fault - Visit a digital tachograph workshop to have the equipment checked.
Ⓜ!Ⓜ↕ d/m download card	Message Indicates the time to next download of the card (Day/Month).	Prepare for download.
!Ⓜ↕ d/m download vehicle	Message Indicates the time to next download from the tachograph.	Prepare for download.

Display	Description	Action
	graph (Day/Month).	
↕↕ Download complete	Message The tachograph download process has been completed successfully.	No further action required.
ⓄⓂ/Ⓞ× Driving can't open slot	Message An attempt was made to open the slot while the vehicle was in motion. Related to the operator.	Stop the vehicle. The card tray can be opened only when the vehicle is stationary.
!ⓄⓂ Driving w/o valid card	Warning Driving without an appropriate card, or with an inappropriate card combination. Related to the operator.	Stop and remove inappropriate card.
!Ⓞ▶ end of daily drive	Warning Maximum daily driving time	
!Ⓞ end of weekly drive	Warning Maximum weekly driving time	
!Ⓞ* end of weekly work	Warning The weekly working time is reached according to the 60 h WTD rule.	
!Ⓞ end of 2-week drive	Warning Maximum 2-week driving time	
fn× Function not possible	Message The desired function cannot be carried out. Related to the tachograph.	Check if the tachograph is set in the correct mode of operation. If the display still shows - Visit a digital tachograph workshop to have the equipment checked.
!ⓄⓂ Hardware sabotage	Fault Card has been removed by force or a tampering with the hardware has been detected. Related to the oper-	Visit a digital tachograph workshop to have the equipment checked.

Display	Description	Action
	ator.	
!■ Insertion of a non valid card	Warning A non-valid card has been inserted to a slot. Related to the operator.	Eject the non-valid card.
!■A1 Last sess. not closed ok	Warning The driver card in tray 1 was ejected incorrectly during the last session. The previous card withdrawal in tray 1 was not completed correctly by the tachograph. Similar message for tray 2. Related to the card.	Eject the card and check it visually. Clean the card with a soft damp cloth and try again. Still faulty - perform a self test, see heading Built-in Test on page 54.
⌘→✓ Lock-in complete	Message The lock-in is completed.	No further action required.
←⌘✓ Lock-out complete	Message The lock-out is completed.	No further action required.
!⌚ 30' max interruption	Indication of the remaining interruption time	
M.....! Memory full!	Message Manual entries memory full. Related to the operator.	Modify the manual entries so that the total number of entries is less.
New time? ● 03:01	Message Daylight saving time changes.	Answer YES to start or end daylight saving time. Answer NO or press the Back button to cancel.
!ATd/m next calibration	Warning Next mandatory calibration has to be carried out (d/m = Day/Month)	Plan for the calibration.

Display	Description	Action
!@/T# No driver/ workshop card	Message A function has been selected that requires an inserted driver or workshop card. Related to the operator.	Visit a digital tachograph workshop to have the equipment checked.
!@!#? No further details	Fault An unknown type of sensor error occurred. Related to the motion sensor.	Visit a digital tachograph workshop to have the equipment checked.
>> Over speeding	Warning The vehicle speed has exceeded the speed limit set for 1 minute and will be stored. Related to the operator.	Observe the specified speed limit. Find out the maximum speed allowed for the vehicle.
>>> Overspeeding pre-warning	Message The vehicle is exceeding the over speed limit set. After 1 (one) minute of continuous over speeding the warning will be stored. Related to the operator.	Observe the specified speed limit.
!# Power supply interruption	Warning The tachograph supply voltage is below or above the limit for correct operation or has been disconnected. Related to the vehicle. Warning The power supply to the tachograph has been interrupted for more than 200 milliseconds. Cranking voltage should not cause this event. The event is not generated in calibration mode. Related to the vehicle.	Visit a digital tachograph workshop to have the equipment checked.
▼↑□ Printer high temperature	Message The printing could not start, or the ongoing printing has been interrupted, because the temperature of the printer is too high. Related to the printer.	Wait until the printer temperature is in allowable range and try to print again. Visit a digital tachograph workshop to have the

Display	Description	Action
		equipment checked.
▼↓† Printer low power	Message The ongoing printing has been interrupted because the tachograph input voltage is too low. Related to the vehicle.	Check that the ignition is on. Check the vehicle battery voltage, connections, etc. If the printer still is faulty - Visit a digital tachograph workshop to have the equipment checked.
▼↓□ Printer low temperature	Message The printing could not start because the temperature of the printer is too low. Related to the printer.	Wait until the printer temperature is in allowable range and try to print again. If the printer still is faulty - Visit a digital tachograph workshop to have the equipment checked.
▼E× Printer out of paper	Message The ongoing printing has been interrupted because the printer is out of paper.	Replace paper.
Printing busy 	Message The printing is ongoing.	Wait until the printout is finished. Press and hold the Back button to cancel the printout
▼×▼ Printing cancelled	Message The ongoing printing has been cancelled.	No further action required.
▼✓▼ Printing complete	Message The ongoing printing has been completed.	No further action required.
>4 1/2h? Quarter left reminder	Message The driver has 15 minutes left until the legal maximum continuous driving time of 4½ hours will be exceeded.	Find a suitable place to take a break in the next 15 minutes.
?*6h reminder	Pre-warning	

Display	Description	Action
break	A reminder for a break according to the 6 h WTD rule.	
?▶lh reminder daily rest	Pre-warning A reminder for the daily rest.	
!▶lhh reminder weekly rest	Pre-warning A reminder for the weekly rest.	
xAAl secondary sensor fault	Fault No or erroneous data from the second source motion sensor. Related to the motion sensor.	Visit a digital tachograph workshop to have the equipment checked.
!@l Sensor auth. failure	Fault The tachograph does not detect the sensor. Related to the motion sensor.	Visit a digital tachograph workshop to have the equipment checked.
!@lA Sensor auth. failure	Fault The tachograph does not recognise the connected sensor as the one installed. Related to the motion sensor. Fault An unsuccessful authentication attempt of the motion sensor has been detected. Related to the motion sensor.	Visit a digital tachograph workshop to have the equipment checked.
!l=0 Sensor cable fault	Warning Sensor data error. Related to the motion sensor.	Visit a digital tachograph workshop to have the equipment checked.
!l>0 Sensor cable fault	Warning Motion sensor data error. Related to the motion sensor.	Visit a digital tachograph workshop to have the equipment checked.
xlA Sensor comms error	Fault Motion sensor communication error. Related to the motion sensor.	Visit a digital tachograph workshop to have the equipment checked.

Display	Description	Action
!M Sensor data error	Warning Signal failure between motion sensor and tachograph. Related to the motion sensor.	Visit a digital tachograph workshop to have the equipment checked.
!MM/M Sensor data integrity error	Fault Internal motion sensor error, stored data integrity failure. Related to the motion sensor	Visit a digital tachograph workshop to have the equipment checked.
!M→Mx Sensor data transfer error	Fault The motion sensor and tachograph do not communicate. Related to the motion sensor.	Visit a digital tachograph workshop to have the equipment checked.
xM√ Sensor fault no acknowledge	Fault Motion sensor communication error. Related to the motion sensor.	Visit a digital tachograph workshop to have the equipment checked.
M→A... Sensor pairing	Message The motion sensor and tachograph is in the process of pairing. Related to the motion sensor.	Wait until the automatic pairing is completed.
xAM↑ Sensor power high	Fault Motion sensor power too high. Related to the motion sensor.	Visit a digital tachograph workshop to have the equipment checked.
xAM↓ Sensor power low	Fault Motion sensor power too low. Related to the motion sensor.	Visit a digital tachograph workshop to have the equipment checked.
!M† Sensor no power signal	Fault Motion sensor has no power. Related to the motion sensor.	Visit a digital tachograph workshop to have the equipment checked.
!M∠x Sensor unauth. case open	Fault Unauthorized opening detected. Related to the motion sensor.	Visit a digital tachograph workshop to have the equipment checked.

Display	Description	Action
A→T? Service pre-warning	Message Next calibration, pre-warning.	Visit a digital tachograph workshop to have the equipment checked.
>4 1/2h Time for break	Message The legal maximum continuous driving time of 4½ hours has elapsed.	
!#6h time for break	Warning Take a break according to the 6 h WTD rule	Minimum break 15 min
!A→T Time for service	Message The tachograph is out of calibration.	Visit a digital tachograph workshop to have the equipment checked.
!▷lh time for daily rest	Warning A warning for start of daily rest.	
!▷lhh time for weekly rest	Warning A warning for start of weekly rest.	
■→Ⓞ Timeout no key pressed	Message The tachograph is waiting for input.	Press the appropriate buttons and complete the process.
!Ⓞ UTC adjust not allowed	Message UTC time adjustment more than +/- 1 (one) minute once a week is not allowed.	If the UTC time in the tachograph has deviated by more than 20 minutes, it must be calibrated by a digital tachograph workshop.
xⓄ/ⓄZx Unable to open slot	Message The card tray concerned cannot be opened. Related to the tachograph.	Check that the ignition is on. If the tray is still faulty - Visit a digital tachograph workshop to have the equipment checked.
!Ⓞll Unauth. change of sensor	Fault The sensor has been changed since last pairing. Related to the motion sensor.	Visit a digital tachograph workshop to have the equipment checked.
!AZx Unauth. UU opening	Fault The Tachograph unit case has been opened. Related	Visit a digital tachograph workshop to have the equipment checked.

Display	Description	Action
	to the tachograph.	
x A UU internal fault	Fault The tachograph has detected an internal fault. Related to the tachograph.	Visit a digital tachograph workshop to have the equipment checked.
x A II Vehicle Motion Conflict	Message 2nd source of motion sensor and primary motions sensor data contradicts. Related to the motion sensor.	Visit a digital tachograph workshop to have the equipment checked.
Wrong PIN! Card locked 1	Message Wrong PIN entered too many times. [Workshop Card] Related to the card	Eject the card and replace it with a valid one.
? @ II 2-week drive time	Pre-warning Maximum 2-week driving time	
? @ I weekly drive time	Pre-warning Maximum weekly driving time	
? * I weekly work time	Pre-warning Reaching the weekly working time according to the 60 h WTD rule.	

Printout Examples

On the following pages there are a number of printout examples that can be selected from the **PRINT** menu:

- Daily printout (card) **24h card** (including local time).
- Daily printout (VU) **24h vehicle** (including local time).
- Event and faults (card) **event card**.
- Event and faults (VU) **event vu**.
- Drive Time Info **drive time info**
- Technical data **technical data**.
- Overspeeding **overspeeding**.
- Vehicle speed **vehicle speed**.
- Engine speed (rpm) **engine speed**.
- Status D1/D2 **status D1/D2**.
- Manual Entry Sheet **man entry sheet**.

The following example is a confirmation after a manual entry.

- Manual Entry Confirmation

Daily Printout (card)

This printout lists all activities stored on the driver card (or co-driver card) for the selected date (legal requirement). UTC time is used.

The display shows the following (on the second line):

24h card

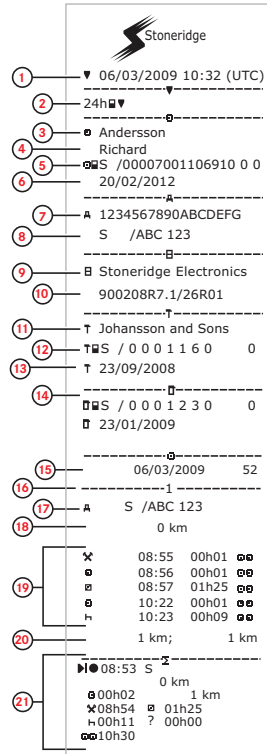

1. Printout date and time.
2. Type of printout (24h, card).
3. Card holder's surname.
4. Card holder's first name.
5. Card and country identification number.
6. Expiry date of the driver card.
7. Vehicle identification, VIN.
8. Registering member state and Vehicle Registration Number, VRN.
9. Tachograph manufacturer.
10. Tachograph part number.
11. Responsible workshop for last calibration.
12. Workshop card number.
13. Date of last calibration.
14. Last control the inspected driver has been subjected to.
15. Enquiry date and daily card presence counter.
16. Tray where card was inserted
17. VRN, Vehicle Registration Number, for the vehicle where the driver card was inserted.
18. Vehicle odometer at card insertion.
19. Activities with driver card inserted, start and duration time.
20. Card withdrawal: Vehicle odometer and distance travelled since last insertion for which odometer is known.
21. Daily summary of activities.

Daily Printout (card) continued

To make it easier to check the activities on the printout you can select local time instead of UTC. The printout contains in all other respect the same information.

Note!

The text OUT OF REGULATION indicates that this printout doesn't comply with any regulation.



▼ 26/11/2007 08:41 (●) (●)

** OUT OF REGULATION **

24h ▼ UTC+01h00

⊞ Andersson
Richard

⊞S /ABCD6789012345 1 1
31/12/2012

A 1234567890ABCDEF

S /123 A 23F

-----!XA-----

!⊞ 27/02/2009 16:32
!11 93h41
A S /ABC 123

X⊞ 05/03/2009 15:20
X35 17h32
A S /ABC 123

!⊞ 05/03/2009 15:20
!11 17h32
A S /ABC 123

X⊞ 06/03/2009 08:55
X35 01h37
A S /ABC 123

!⊞ 06/03/2009 08:55
!11 01h37
A S /ABC 123

-----!XA-----

X⊞ 00 03/03/2009 09:15
X35 05h10
⊞

!⊞ 00 03/03/2009 09:15
!11 05h10
⊞

!+ 01 03/03/2009 14:26
!08 (1) 48h53
⊞

X⊞ 07 05/03/2009 15:20
X35 19h12
⊞S /00007001106910 0 0
⊞S /00007001106880 0 0

!⊞ 07 05/03/2009 15:20
!11 19h12
⊞S /00007001106910 0 0
⊞S /00007001106880 0 0

-----!XA-----

⊞

⊞

⊞

22. Last five events and faults from the driver card.
23. Last five events and faults from the VU, vehicle unit.
24. Control place.
25. Controller's signature.
26. Driver's signature.

Daily Printout (VU)

This printout lists all activities stored in the tachograph (VU) for the selected date (legal requirement). UTC time is used. The printout is dependent of the following:

- If no card is inserted, select either the current day or any of the eight recent days.
- When a card is inserted, select any day stored in the tachograph, out of a maximum of typically the recent 28 days. If no data is available for the selected date, the printout will not be initiated.

The display shows the following (on the second line):

24h vehicle

The screenshot shows a tachograph printout from Stoneridge. The data is as follows:

```

Stoneridge
1 06/03/2009 10:39 (UTC)
2 24h
3
4 Andersson
  Richard
5 S /00007001106910 0 0
6 20/02/2012
7 Schmidt
  Magnus
8 S /00007001106880 0 0
9 20/02/2012
10
11
12 06/03/2009
13 0 - 1 km
14 Andersson
  Richard
  S /00007001106910 0 0
  20/02/2012
15 A -> S /ABC 123
16 03/03/2009 11:45
17 0 km
  00:00 08h53
  0 km; 0 km
18 0 km
  08:53 00h02
  0 km; 0 km
  Andersson
  Richard
  S /00007001106910 0 0
  20/02/2012
  A -> S /ABC 123
  06/03/2009 10:26
  0 km
  08:55 00h01
  08:56 00h01
  08:57 01h25
  10:22 00h01
  10:23 00h16
  1 km; 1 km
  
```

1. Printout date and time.
2. Type of printout (24h, VU).
3. Card holder's surname (driver).
4. Card holder's first name (driver).
5. Card and country identification number.
6. Expiry date of the driver card.
7. Card holder's surname (co-driver).
8. Card holder's first name (co-driver).
9. Card and country identification number.
10. Expiry date of the co-driver card.
11. Drivers activities stored in the VU per slot in chronological order.
12. Enquiry date.
13. Vehicle odometer at 00:00 and 24:00.
14. Driver
15. Registration member state and vehicle registration number of previous vehicle used.
16. Date and time of card withdrawal from previous vehicle.
17. Vehicle odometer at card insertion.
18. Activities with start and duration time

Daily Printout (VU) continued

M=Manual entries of driver activities.

To make it easier to check the activities on the printout you can select local time instead of UTC. The printout contains in all other respect the same information.

Note!

The text OUT OF REGULATION indicates that this printout doesn't comply with any regulation.

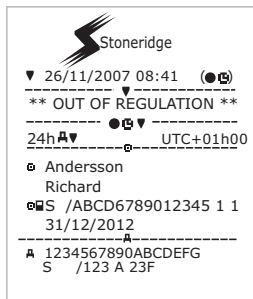

19	□ Schmidt Magnus
20	□ S /00007001106880 0 0 20/02/2012
21	A → S /ABC 123 05/03/2009 14:40
22	□ 00:00 08h53 □ □ 0 km; 0 km; 0 km
	□ Schmidt Magnus
	□ S /00007001106880 0 0 20/02/2012
	A → S /ABC 123 06/03/2009 10:25
	□ 08:55 00h01 □ □ M 0 km
	h 08:56 01h43 □ □ * 1 km; 1 km
23	1 □ □ □ 00h00 0 km ✕ 00h02 □ 00h00 h 00h00
24	2 □ □ ✕ 00h00 □ 00h02 h 00h00
25	□ Andersson Richard
	□ S /00007001106910 0 0
	h 08:53 S □ 00h02 0 km 1km ✕ 08h54 □ 01h25 h 00h16 □ 10h37
26	□ Schmidt Magnus
	□ S /00007001106880 0 0
	h 08:53 S □ 00h00 0 km 1km ✕ 00h00 □ 08h54 h 01h43 □ 10h37

19. Co-driver.
20. Registration member state and vehicle registration number of previous vehicle used.
21. Date and time of card withdrawal from previous vehicle.
22. Vehicle odometer at card insertion.
M = Manual entries of driver activities.
* = Rest period of at least one hour.
23. Summary of periods without card in driver slot.
24. Summary of periods without card in co-driver slot.
25. Daily summary of activities (driver).
26. Daily summary of activities (co-driver).

Events and Faults (card)

This printout lists all warnings and faults stored on the card (legal requirement). UTC time is used.

The display shows the following (on the second line):

event card

Stoneridge

1 20/07/2007 09:48 (UTC)

2 !X

3 Andersson

4 Richard

5 S /ABCD6789012345 1 1

6 31/12/2012

7 A S /123 A 23F

8

A	24/1/2007	07:30
A S	/123 A 23F	00h05

9

I	3/2/2007	15:30
I 35		00h00

X	29/2/2007	06:41
X 35		00h23

X	14/3/2007	11:30
X 35		01h05

10 *

11

12

1. Date and time.
2. Type of printout. (event and faults, card).
3. Card holder's surname.
4. Card holder's first name.
5. Card and country identification number.
6. Expiry date of the card.
7. Vehicle registration number VRN.
8. List of all events stored on the card.
9. List of all faults stored on the card.
10. Control place.
11. Controller's signature.
12. Driver's signature.

Events and Faults (VU)

This printout lists all warnings and faults stored in the tachograph or vehicle unit (legal requirement). UTC time is used.

The display shows the following (on the second line):

event vehicle

The diagram shows a tachograph printout with the following fields and callouts:

- 1: Date and time: 20/07/2007 09:48 (UTC)
- 2: Type of printout: XAV
- 3: Card holder's surname: Andersson
- 4: Card holder's first name: Richard
- 5: Card and country identification number: S /ABCD6789012345 1 1
- 6: Expire date of the driver card: 31/12/2012
- 7: Vehicle identification: A 1234567890ABCDEF S /123 A 23F
- 8: List of all events stored in the VU:
 - !G02 07/02/2007 06:24
 - !04 (10) 00h00
 - A 1234567890ABCDEF S /123 A 23F
- 9: List of all faults stored in the VU:
 - XD03 07/02/2007 08:42
 - X35 00h00
 - A 1234567890ABCDEF S /123 A 23F
 - XA01 07/02/2106 06:24
 - X31 00h00
 - A 1234567890ABCDEF S /123 A 23F
- 10: Control place: □•
- 11: Controller's signature: □
- 12: Driver's signature: □

1. Date and time.
2. Type of printout. (event and faults, VU).
3. Card holder's surname.
4. Card holder's first name.
5. Card and country identification number.
6. Expire date of the driver card.
7. Vehicle identification. VIN, registering member state and VRN.
8. List of all events stored in the VU.
9. List of all faults stored in the VU.
10. Control place.
11. Controller's signature.
12. Driver's signature.

Drive Time Info

This printout lists drive time information.

The display shows the following (on the second line):

```
drive time info
```

Note!

Nos. 16 through 20: These summary lines are only printed if there are any warnings present.

Note!

No. 8: The question mark after the value indicates that UNKNOWN periods have been assimilated to BREAK/REST.

Stoneridge

- 20/07/2007 09:48 (UTC+01:00)
-
-
- Andersson Richard
- S /ABCD6789012345 1 1
- 31/12/2012
-
- 12/2/2011 19:24 [?]
- 1 02h51
- 1 00h13
- 10h29 (>9h: 2)
- 12h24
- |
- ||
-
- 31/12/2012
- 12/04/2011
-
- 12/04/2011
- 12/12/2011

1. Date and time.
2. Shows the time difference between UTC and local time.
3. Type of printout (driver's time summary).
4. Card holder surname and first name
5. Card holder ID.
6. Card expiry date.
7. Driver's time summary
8. End of the last daily/weekly rest period.
9. Driver's continuous driving time.
10. Driver's accumulated break time.
11. Daily driving time, in parenthesis - the number of times when the driving time has exceeded 9 hours during the current week.
12. Time left before the driver must start the daily/weekly rest period.
13. Weekly driving time.
14. Two weeks driving time.
15. Driver card summary.
16. Driver card expiry date.
17. Date of the next mandatory driver card download.
18. Vehicle unit (tachograph) related times summary.
19. Date of the next mandatory VU download.
20. Date of the next mandatory VU calibration.

Technical Data

This printout list data as speed settings, tyre size, calibration data and time of adjustments.

The display shows the following (on the second line):

technical data

1 19/10/2010 08:41 (UTC)
 2 T
 3 Andersson Richard
 S /00007001106910 0 0
 23/05/2015
 4 A ABCD1E2345678910
 5 NL /AA-BB-12
 6 B Stoneridge Electronics
 Adolfsbergsvägen 3
 S70227 örebro
 7 900208E7.3/01R01
 8 SVN31309
 9 1234567890/7878/06/A2
 10 2010
 11 v P477 31/07/2010
 12 l 1234567890/1006/07/A1

13 e1-175
 14 05/08/2010
 15 T STONERIDGE ELECTRONICS
 16 168 66 BROMMA
 17 T S /12345678901012 1 0
 31/08/2016
 18
 19 T 05/08/2010 (1)
 20 A NL /AA-BB-12
 21 /?????????????
 22 w 9 150 Imp/km
 23 k 9 150 Imp/km
 24 l 3 331 mm
 25 315/80 R22.5
 26 > 89 km/h
 27 15 km; 15 km
 T Johansson and Sons
 123 45 BROMMA
 T S /12345678901012 1 0
 31/08/2016
 28 T 06/08/2010 (2)
 29 A ABCD1E2345678910
 30 NL /AA-BB-12
 w 9 150 Imp/km
 k 9 150 Imp/km
 l 3 331 mm
 315/80R22.5
 > 89 km/h
 0 km; 26 km
 31 ! 06/08/2010 10:40
 32 06/08/2010 10:41
 T Johansson and Sons
 123 45 BROMMA
 T S /12345678901012 1 0
 ! x A
 33 ! 19/10/2010 08:40
 34 x 19/10/2010 08:40
 ATTACHMENT
 A l
 35 Input: A-CAN
 Type: EBC2

1. Date and time.
2. Type of printout. (technical data).
3. Cardholder ID.
4. Vehicle Identification Number (VIN).
5. Vehicle Registration Number (VRN) and country of registration.
6. Tachograph manufacturer.
7. Tachograph part number.
8. Tachograph approval number.
9. Tachograph serial number, date of manufacture, type of equipment and code of manufacturer.
10. Year of manufacture.
11. Software version and installation date.
12. Motion sensor serial number.
13. Motion sensor approval number.
14. Date of first installation of motion sensor.
15. Workshop having performed the calibration.
16. Workshop address.
17. Workshop card identification.
18. Workshop card expiry date.
19. Calibration date.
20. VIN
21. VRN and country of registration.
22. Characteristic coefficient of vehicle.
23. Constant of the recording equipment.
24. Effective circumference of wheel tyres.
25. Vehicle tyre size.
26. Authorized speed setting.
27. Old and new odometer values.
28. Calibration date and purpose.
29. VIN.
30. VRN and country of registration.
31. Old date and time. (Before time adjustment)
32. New date and time. (After time adjustment)
33. Most recent event time.
34. Most recent fault date time.
35. Second source configuration. If not shown second source is disabled.

Overspeeding

This printout lists overspeeding events together with duration and the name of the driver.

The display shows the following (on the second line):

overspeeding

Stoneridge

1 20/07/2007 09:48 (UTC)

2 >> 89 km/h

3 Andersson

4 Richard

5 S /ABCD6789012345 1 1

6 31/12/2012

7 1234567890ABCDEF

8 S /123 A 23F

9 12/02/2007 19:24:00h05
98 km/h 94 km/h (1)
Andersson
Richard
S /ABCD6789012345 1 1

10 >>(365)-----
> 9/02/2007 11:31 00h10
99 km/h 97 km/h
Svensson
Bertil
S /EFGH123456786 2 2

11 >>10)-----
> 12/02/2007 19:24 00h05
98 km/h 94 km/h (1)
Andersson
Richard
S /ABCD6789012345 1 1

12 *

13

14

1. Date and time.
2. Type of printout. (overspeeding). Speed limiting device setting.
3. Card holder's surname.
4. Card holder's first name.
5. Card and country identification number.
6. Expiry date of the driver card.
7. Vehicle identification. VIN, registering member state and VRN.
8. Date and time of the last overspeeding control.
9. Date and time of first overspeeding and number of overspeeding events.
First overspeeding after the last calibration.
Date time and duration. Max and average speed.
Driver and drivers card identification.
10. Five most serious overspeeding over the last 365 days. Date time and duration. Max and average speed. Driver and drivers card identification.
11. Most serious overspeeding events over the last ten days. Date time and duration. Max and average speed. Driver and drivers card identification.
12. Control place.
13. Controller's signature.
14. Driver's signature.

Vehicle Speed

This printout lists the vehicle speed organized chronologically in speed bands (km/h) for each driver.

The display shows the following (on the second line):

vehicle speed

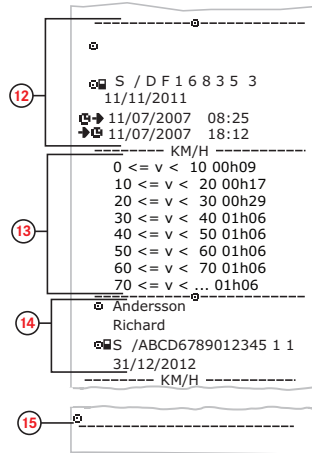
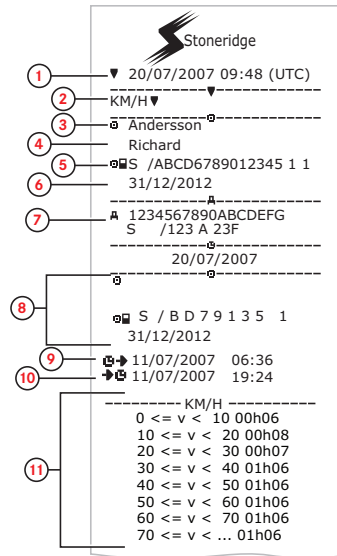

1. Date and time.
2. Type of printout. (vehicle speed).
3. Card holder's surname.
4. Card holder's first name.
5. Card and country identification number.
6. Expiry date of the driver card.
7. Vehicle identification. VIN, registering member state and VRN.
8. Information about previous driver (In chronological order).
9. Previous drivers start date and time.
10. Previous drivers end date and time.
11. Speed band and duration time.
12. Information about previous driver (In chronological order).
13. Speed band and duration time.
14. Latest driver card information.
15. Driver's signature.

Engine Speed (rpm)

This printout lists the vehicles engine speed in bands of rpm in chronological order for each driver.

The display shows the following (on the second line):

engine speed

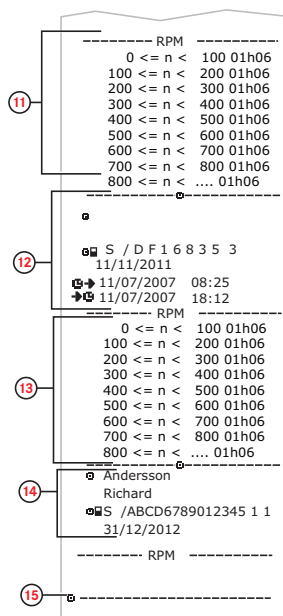
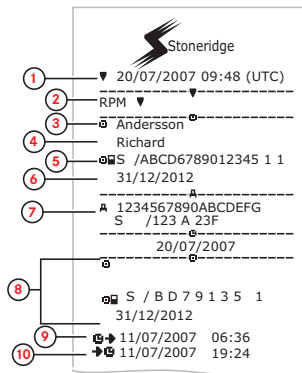

1. Date and time.
2. Type of printout. (engine speed).
3. Card holder's surname.
4. Card holder's first name.
5. Card and country identification number.
6. Expiry date of the driver card.
7. Vehicle identification. VIN, registering membership state and VRN.
8. Information about previous driver (In chronological order).
9. Previous drivers start date and time.
10. Previous drivers end date and time.
11. Speed band of engine and duration time.
12. Information about previous driver (In chronological order).
13. Speed band of engine and duration time.
14. Latest driver card information.
15. Driver's signature.

Status D1/D2

This printout lists the changes of status of the rear connectors (D1 and D2). The output of the rear connectors are company specific.

The display shows the following (on the second line):

status D1/D2

Stoneridge

1 20/07/2007 09:48 (UTC)

2 STATUS 1/2

3 Andersson

4 Richard

5 S /ABCD6789012345 1 1

6 31/12/2012

7 A 1234567890ABCDEFG

8 S /123 A 23F

15/07/2007

STATUS 1/2

STATUS	D1	D2	TIME
1	0		
0	0	00:00:48	
0	1	00:01:36	
1	0	00:04:48	
0	1	00:08:48	
1	1	00:13:52	
0	1	00:17:36	
1	0	00:21:36	
1	1	00:25:52	

10

1. Date and time.
2. Type of printout. (Status D1/D2).
3. Card holder's surname.
4. Card holder's first name.
5. Card and country identification number.
6. Expiry date of the driver card.
7. Vehicle identification. VIN, registering member state and VRN.
8. Selected date of printout.
9. Changes of status for the connectors and timestamp.
10. Driver's signature.

Manual Entry Sheet

This is a printout sheet for hand writing of data.

The display shows the following (on the second line):

man entry sheet

The diagram shows a printout sheet with the following fields and callouts:

- 1. Date and time (local time): 26/11/2007 07:41 (●●)
- 2. Type of printout (Manual Entries): MO
- 3. Card holder's name and identification number: Andersson Richard
- 4. Vehicle identification. VIN, registering member state and VRN: S /ABCD6789012345 1 1 31/12/2012
- 5. Card withdrawal time: A 1234567890ABCDEFG S /123 A 23F
- 6. Manual entries with duration time: A → 23/11/07 08:41
- 7. Card insertion time: → A 23/11/07 16:23
- 8. Driver's signature: (empty field)

1. Date and time (local time).
2. Type of printout (Manual Entries).
3. Card holder's name and identification number.
4. Vehicle identification. VIN, registering member state and VRN.
5. Card withdrawal time.
6. Manual entries with duration time.
7. Card insertion time.
8. Driver's signature.

Data and Specifications

DDS Calculations and Limits

DDS does a *best effort* calculation to support drivers and fleets in their compliance with Regulation (EC) 561/2006. Stoneridge shall not be held responsible for any defects or shortcomings in this function.

DDS generally takes the following into account in its internal calculations:

- Activity data on driver card.
- General requirements in Regulation (EC) 561/2006 on drive time, breaks, rests and calendar weeks.
- Requirements in the Working Time Directive 2002/15/EC.
- Includes calculation of Ferry/Train travelling time.
- Time of the VU internal clock, in the UTC time zone.

The data presented by DDS may in some cases differ from what regulation states or how it may be interpreted by some control officers, especially in (but not limited to) some special cases:

- Periods of driving mixed between analogue and digital tachographs, with new driver cards or without driver cards, in which case relevant data may be missing on the driver card.
- Extremely frequent activity changes.
- Malfunctioning driver card.
- Some uses of Out of Scope special conditions.
- Driving in non-EU AETR countries.
- International coach bus transports where the 12 day derogation applies.
- Other exceptions where Regulation (EC) 561/2006 does not apply.
- Use of compensatory weekly rest.
- Certain combinations of reduced and regular weekly rests starting and ending in separate calendar weeks.
- Optional use of AVAILABILITY activity for breaks.
- Large deviations in time adjustment between vehicle units where the driver card has been inserted.
- Multi-manning when drivers have started their daily working periods at separate times.

DDS in Details

This table reflects what the DDS covers and not covers.

Type	Support YES/NO
Daily driving time 4.5 + 4.5h	YES
Extended driving time 10h	YES
Number of extended driving times during a 2-week period	YES
Daily break 45 min	YES
Divided break 15-30 min	YES
Daily rest 11h	YES
Reduced daily rest 9h	YES
Split daily rest 3+9h	YES
Number of reduced daily rests since last weekly rest (max 3)	YES
Max interval between daily rests (24h if single driver)	YES
Weekly driving time 56h	YES
2-week driving time 90h	YES
Weekly rest 56h	YES
Reduced weekly rest 24h	YES
Max interval (144h since end)	YES
Assigning to one week	YES
Multi-manning	YES
Regular/reduced rests in two week period (1+1)	YES

12 days derogation rule for international bus transports.	NO
Compensatory weekly rest.	NO
Working time directive.	YES
Interruptions of daily rest for ferry/train, e.g. driving on or off a ferry or train	YES
AETR specific rules	NO

Note!
All calculations are based on fixed weeks in UTC time and not on local time weeks.

Certification and Approval

The tachograph is approved for use in the European Union and certified to ITSEC level E3 high in accordance with EU legislation.

Type approval number: e5-0002.

Avoid High Voltage

Interrupt the power supply to the tachograph if you expect that the vehicle will require several jump-starting attempts.

For more information on how to interrupt the tachograph power, see the vehicle's operating manual.

It might be necessary to re-calibrate the tachograph if the power is interrupted.

Note!
High voltage may lead to permanent tachograph damage and to failure of the tachograph's electronic components. Damage to the tachograph caused in this way invalidates the warranty.

Data stored in the Tachograph

The tachograph records and stores various data:

- Driver card data, except from driving license data.
- Warnings and malfunctions related to the tachograph and the driver, company and workshop cards.
- Vehicle information, odometer data and detailed speed for 24 hours.
- Tampering with the tachograph.
- Vehicle speed is stored continuously.

Note!
Over speeding for more than one minute will be stored in the tachograph.

Insertion and Withdrawal Data

Data stored for each driver card:

- Card holder's surname and first name.
- Driver card number, card issuing member state and the card expiry date.
- Date and time at driver card insertion and withdrawal.
- Vehicle odometer value at driver card insertion and withdrawal time.
- The vehicle registration number and registering member state of the vehicle.
- Card withdrawal time for the last vehicle in which the driver card was inserted.
- In which tray the driver card is inserted.
- Indication if manual entries of activities have been made.
- Driver's tachograph language choice.

Driver Activity Data

Data stored for each day and change of driving activity:

- Driving status: single or part of a crew.
- Card tray used in the tachograph.
- Card inserted or not inserted at the time of change of activity.
- Driver activity.
- Date and time of activity change.

Other Data

Other data stored in the tachograph:

- Detailed vehicle speed.
- Vehicle overspeeding for at least 1 minute.
- Company and workshop events

Data stored on the Card

The driver card is unique for each driver and therefore it identifies the card holder. In addition the card stores various data:

- Driving time, activities and distance.
- Drivers license information.
- Some warnings and malfunctions.
- Vehicle Registration Number (VRN) for vehicles used by the card holder.
- Controls performed by authorities.

Data is stored automatically on the card, when so is needed. In a co-driver operation, data for both driver and co-driver are stored on the cards respectively.

Note!

Normally the driver card can store data for at least 28 days. After this time, the oldest data is over written when new data is stored.

Insertion and Withdrawal Data

Data stored for each day and vehicle:

- Date and time for the first driver card insertion and last withdrawal.
- Vehicle odometer value at first driver card insertion and last withdrawal.
- The vehicle registration number and registering member state of the vehicle.

Driver Activity Data

Data stored for each day and change of driving activity:

- Date and daily presence counter.
- The total distance travelled by the driver card holder.
- The driving status at every midnight or at card insertion, single driver or part of a crew.
- A record of each driving activity change.
- Driving status: driver or co-driver.
- Card tray used in the tachograph.
- Card inserted or not inserted at the time of change of activity.
- Driver activity.
- Date and time of activity change.

Electromagnetical Compability

The tachograph fulfils the requirements of UNECE regulation number 10, revision 03, approval No 03126, in respect of electromagnetic compatibility.

Tachograph Version

Digital Tachograph SE5000 Rev 7.5.

Operating Temperature

-25°C to +70°C

Hazardous goods version in accordance
with ADR: -25°C to +65°C.

ADR Tachograph

Hazardous Goods Vehicles

The ADR version of the tachograph is approved for use in hazardous goods vehicles. It differs from the standard tachograph as it has explosion protection and is certified in accordance with EU Directive 94/9/EC.

TÜV (Technischer Überwachungs Verein) test certificate number: ATEX 2507 X, with corresponding supplements.

Note!

The ADR tachograph explosion protection is only guaranteed when the vehicle is stationary and the battery isolating switch is open.

The ADR Tachograph

For the ADR Tachograph some functions are disabled immediately when the ignition is switched off:

- Card trays cannot be ejected.
- Printouts are not possible.

- Background illumination for buttons and display is switched off.

Note!

The ADR Tachograph will enter the power saving mode immediately after the ignition is switched off.

To have the ADR Tachograph fully operational, the ignition key must be in position key-on or ignition on, depending on your vehicle manufacturer.

Visible Differences

The following visible differences between a standard Tachograph and an ADR Tachograph:

1. **Ex** symbol on the Tachograph front
2. ADR classification
3. TÜV test certificate number

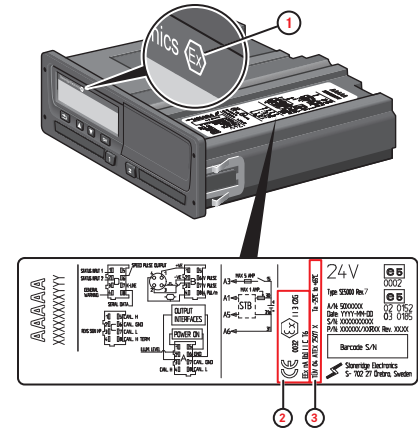

Contact Stoneridge

You are welcome to forward any queries or suggestions you may have about the Tachograph and the operating instructions to any of our sales offices, as listed below.

United Kingdom

Stoneridge Electronics Ltd
Charles Bowman Avenue
Claverhouse Industrial Park
Dundee DD4 9UB, Scotland
UK

Phone: +44 (0)1382 866 400
Fax: +44 (0)1382 866 401
E-mail: amsales@stoneridge.com

France

Stoneridge Electronics France
Z.I St. Etienne
F-64100 Bayonne
France

Phone: +33 (0)5 59 50 80 40
Fax: +33 (0)5 59 50 80 41
E-mail: france.amsales@stoneridge.com

Germany

Stoneridge Aftermarket GmbH
Talweg 8
D-75417 Mühlacker-Lomersheim
Germany

Phone: +49 7041 9695-10
Fax: +49 (0)7041 9695-55
E-mail: infode@stoneridge.com

Italy

Stoneridge Electronics s.r.l.
Viale Caduti nella Guerra di Liberazione,
568
00128 Rome
Italy

Phone: +39 06 50 78 07 87
Fax: +39 06 50 89 001
E-mail: italy.amsales@stoneridge.com

Netherlands

C.A.S.U. - Utrecht b.v.
Ravenswade 118
NL-3439 LD Nieuwegein
Netherlands

Phone: +31 (0)30 288 44 70
Fax: +31 (0)30 289 87 92
E-mail: info@casuutrecht.nl

Spain

Stoneridge Electronics España
Avda. Severo Ochoa 38
Pol. Ind. Casa Blanca
28108 Alcobendas
Madrid
Spain

Phone: +34 91 662 32 22
Fax: +34 91 662 32 26
E-mail: spain.amsales@stoneridge.com

Sweden

Stoneridge Nordic AB
Gårdsfogdevägen 18 A
SE-168 66 Stockholm
Sweden

Phone: +46 (0)8 154400
Fax: +46 (0)8 154403
E-mail: info@stoneridgenordic.se

Index

A

Activities	14, 17
ADR	
ADR tachograph version	86
Special features	86
TÜV certificat	86
Approval	83
Available	14, 17

B

Begin country, see Places	17
Built-in Test	54
Buttons	
Arrow down	9
Arrow up	9
Back	9
Co-driver (2)	8
Driver (1)	8
OK (confirm)	9

C

Calculations and Limits	82
-------------------------------	----

Card Trays (1= Driver, 2 = Co-driver)	8
Certification	83
Change	
Activity when stationary	14
Language	28
manual entry	19
time	29
Contact Stoneridge	1, 87
Control Manual	2

D

DDS (Driver Decition Support)	28, 45, 82
Display	29
Driver view, see Display	8
Driving	14-15

I

Invert display	30
----------------------	----

L

Language	28
----------------	----

M

Manual entries	14, 17
Menus	13
Motions Sensor (Sensor)	9

P

Paper	31
Places	17
Power saving mode	30
Print menu	68
Printer	8
Printout	32

R

Rest	14, 17
------------	--------

S

Safety	1
Sensor	9
Set language	27
Settings	47
Company	43
Driver	27

T

Tachograph	8
Time	29
Trays (1= Driver, 2 = Co-driver) ...	8

U

Unaccounted time	17
------------------------	----

V

Vehicle Unit (Tachograph)	8
VRN (Vehicle Registration Number)	30

W

Work	14, 17
Workshop Manual	2
WTD (Working Time Directive)	43, 47



Stoneridge Electronics Ltd

Charles Bowman Avenue
Claverhouse Industrial Park
Dundee DD4 9UB, Scotland

Tel: +44 (0)1382 866 400
Fax: +44 (0)1382 866 401
E-mail: amsales@stoneridge.com

www.stoneridgeelectronics.com

